



2022 PRODUCT CATALOG

TABLE OF CONTENTS



4

INTRODUCTION TO FIRETECH®



14

HEADLIGHTS

4x6 Headlights
5.75" Round Headlights
7" Round Headlights



20

BAR STYLE FIXTURES

BG2 Lights
Brow Lights
MiniBrow® Lights



34

SURFACE AND RECESSED SCENE LIGHTS

Guardian® Series
Recessed / Semi-Recessed
Under-Aerial



40

COMPARTMENT & UNDERCARRIAGE LIGHTS

HD Strip Lights
Undercarriage Lights



44

LIGHT TOWERS

Will-Burt Tower Lighting
Command Light Tower Lighting



48

POLE LIGHTS

Guardian Pole Mounted
Patriot Pole Mounted
20,000 Raw Lumen LED Scene Light
30,000 Raw Lumen LED Scene Light



52

WORK LIGHTS

WL-X Xtreme Series



58

SPECIALTY LIGHTS

Pixel Ladder Lights
Laser Cannon Lights
Retrofit Lights
FireTech Grilles
Camera Lights



68

LIGHTING ACCESSORIES

Mounting Brackets



ABOUT THE FIRETECH® BRAND BY HIVIZ LED LIGHTING®

AT HIVIZ, WE HELP FIRST RESPONDERS WORK MORE SAFELY AND EFFECTIVELY AFTER DARK.

We do this by providing reliable lighting technologies for emergency vehicles. Our team is dedicated to developing the most innovative, highest quality LED scene lighting solutions on the market.



MORE LIGHT

With the highest luminous efficacy on the market, our fixtures produce more lumens per watt than others on the market. That means more light, where you need it, every single time.



BETTER WARRANTY

Our fixtures are built to last. Therefore, HiViz is proud to offer a Lifetime Warranty WITH advance exchange on all FireTech products. Advance exchange means that we ship you a new fixture first and then you send us the old one back after the swap. We can't promise that you'll never have a problem, but we can promise that we'll take care of it if you do.



SAME COST

Lumen for lumen, HiViz fixtures beat the competition in both performance and price. What does this mean? You get the light output you deserve at a price point you can afford.



DEVELOPED BY FIRST RESPONDERS

We've responded to roadside emergencies in the middle of the night, so we know the challenges that you face. Our team is comprised of first responders and we take our real world knowledge into account when designing and engineering our products.





LIGHTING QUALITY AS A PRIORITY



INGRESS PROTECTION

Products are sprayed from close distances with 80~100 bar water pressure to verify the ingress protection rating, ensuring they are sealed properly.



SUBMERSION & AGING

Every product is run through a submersion (water dunk) test, then placed onto an aging rack and powered up for 30 minutes.



THERMAL IMPACT

Products are placed in a -40°C chamber for 30 minutes and then placed in an 80°C chamber for an additional 30 minutes. Products are then powered up for 72 hours.



LONG TERM DURABILITY

Products are switched on and off 150,000 times repeatedly to ensure that they remain functional after all testing.



CONSUMPTION & INPUT RANGE

All products are tested with a digital power meter to ensure that they are consuming the correct amount of power and have no electrical faults.





MEASURING LIGHT OUTPUT

TOTAL LIGHT VS USABLE LIGHT

LUMENS VS. LUX

Lumens is the measurement of light at the source. Lux (or Foot Candles) is the measurement of light on a specific target. Analogous to fire fighting, lumens is GPM/Flow, lux is where the water droplets land. Changing from fog to straight stream does not affect the flow rate, it just affects where the water lands. Similarly, lumens at the source does not tell you how much light is where you're working, just how much light is produced. Temperature of circuit is analogous to friction loss.

In general, adequate work lighting levels in the Fire/Rescue/EMS industry are defined as somewhere between three and 10 lux on target. At one lux, you generally have enough light to read a newspaper.

USABLE LIGHT = **LUX / F.C.**
 TOTAL LIGHT OUTPUT = **LUMENS**

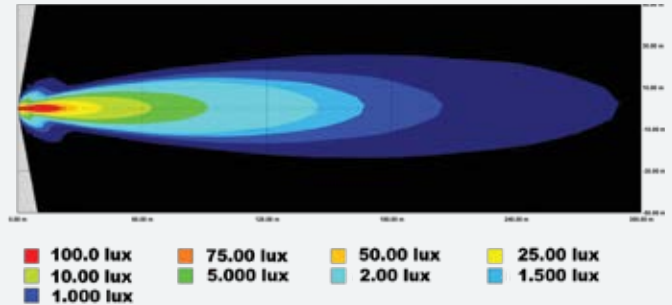

RAW LUMENS VS. EFFECTIVE LUMENS

Lumens are a common standard for measuring light output at the source. It is important to know that the LED chip manufacturer rating is only for the light source in a perfect world, at a perfect temperature and does not account for losses due to optical inefficiencies, electrical inefficiencies, or heat.

The sum of the rated output of the LED chips (Raw Lumens) is not enough to capture the whole story. When measuring effective output, the amount of light lost as heat, optical scattering, or electrical inefficiency must also be considered. Effective lumens are measured in a machine called a goniophotometer and the measurement allows comparisons between fixtures using reproducible scientific "IES" data. This is the ONLY fair way to compare lights made by different manufacturers. HiViz LED Lighting® is happy to provide photometric isolux reports on any product, upon request.

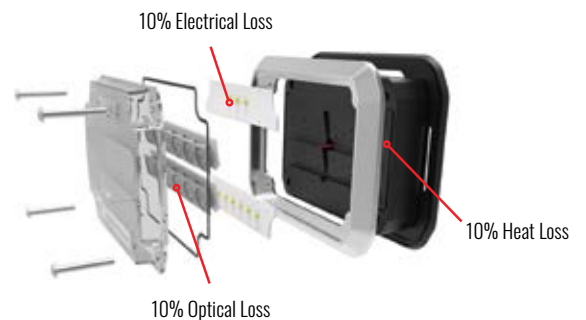



CUSTOM FIT-OUT GUIDE

HOW CAN F.O.G. HELP YOU SEE MORE CLEARLY AT NIGHT?



WHAT TO EXPECT IN A CUSTOM FIT-OUT GUIDE

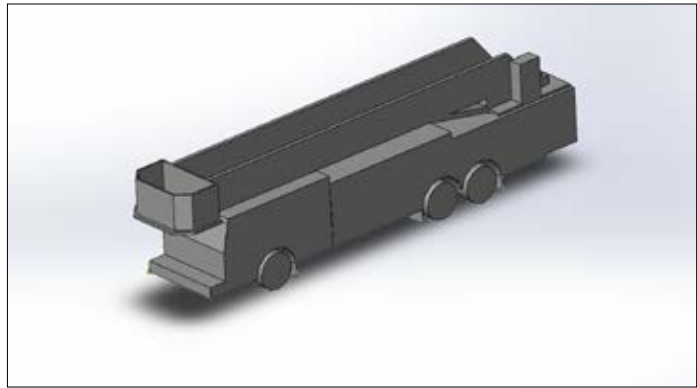
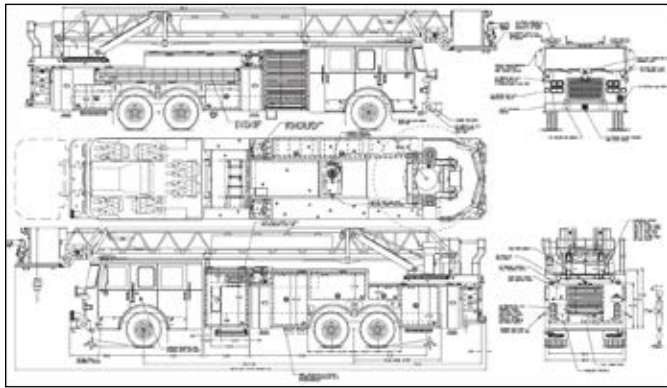

2D BLUE PRINT

We begin each project with a customer/dealer provided drawing of the rig to be outfitted, as well as a quick conversation with the customer on the duties of the particular rig and the response district.

3D MODEL

A 3D model is built using the customer's specifications then carried over into the rendering engine.

Rear Scene Lighting

The grid points in the heat-map rendering are set at 10-foot increments. The fixture provides above 1 lux on the ground around 80' to the rear of the apparatus.

Recommendation: The FT-65MR, also known as the Guardian Junior, is a surface-mounted light with the same design characteristics as the Guardian Elites on the side of the cab. Included in the photo above to show two of these placed in the same location as we are recommending on the rear of your truck. By using these fixtures, the department is avoiding the light being placed right in the line of sight when pulling ladders.

- 1 **FTWL-S-15-FT***
FireTech 30 LED extreme durability scene light, 20,000 lumens, FT combination spot/flood optics that doubles well as a strobe light, for mounting on the front of the bucket, Lifetime Warranty.
- 2 **FTAG-401T**
FireTech 4x4 LED Headlights, Lifetime Warranty.
- 3 **FE55MR**
Guardian Elite surface mounted light, Asymmetric beam pattern, 20,500 lumens, Lifetime Warranty.
- 4 **FTAMB-2-27-F-1***
FireTech Mini Strobe light with two rows of LEDs, 54 LEDs in total, 28,512 lumens, 30-Inches, Recommended all flood optics for the side of the body for lighting a broad area around the rig, Lifetime Warranty.
- 5 **FE55MR**
FireTech Guardian Jr. surface-mounted scene light, 5,000 lumens each, Lifetime Warranty.
- 6 **FTWL-S-8-F-CRBE-FIX**
FireTech 8 LED extreme work light, 12V, 7,200 lumens, Symmetrical flood beam pattern recommended, Recommended mounting on the bottom of the platform, Lifetime Warranty.
- 7 **FTWL-S-8-S***
8 LED extreme work light, 7,200 lumens, Symmetrical beam pattern, Spot optics for aerial spotting lights, Lifetime Warranty.
- 8 **FECL-40-40T**
Sub-Aqua Undercarriage Light, Wide Flood Optics, 17W & 10, Lifetime Warranty. **Mid/White fixtures also available.
- 9 **FECL-40-40T**
Sub-Aqua Undercarriage Light, Wide Flood Optics, 17W & 10, Lifetime Warranty. **Mid/White fixtures also available.
- 10 **FECL-40-40T**
Sub-Aqua Undercarriage Light, Wide Flood Optics, 17W & 10, Lifetime Warranty. **Mid/White fixtures also available.

SIMULATION RENDER

A simulation rendering ensures the final product will meet the customer's lighting requirements, as well as any applicable agency standards.

CUSTOM SOLUTION

We create a complete breakdown of the customer's specific needs to meet their safety requirements.

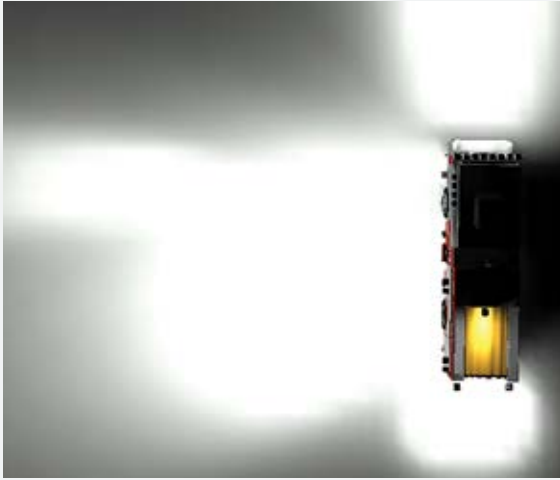

REALISTIC AND ACCURATE FIT-OUT GUIDES

Spec'ing a new rig and don't know where to begin? Send your drawing to have our team recommend a layout! This service doesn't cost anything and it's a great way for you to ensure efficient and thoughtful placement of scene lights around your rig!

Our team can typically produce a detailed rendering within five to ten business days, if provided proper vehicle specifications.

GET YOUR FIT-OUT GUIDE

Fill out this worksheet and text a picture of it to **(703) 662-3458** or email it to **firetech@hivizleds.com** and we'll send you your custom fit out guide.

NAME OF FIRE DEPARTMENT: _____

TYPE OF FIRE DEPARTMENT
(CAREER OR VOLUNTEER): _____

BUDGET: WE'RE ON A TIGHT BUDGET BALANCE PERFORMANCE AND COST WE NEED INSANE AMOUNTS OF LIGHT

DESIGN GOALS/NOTES: _____

TYPE OF TRUCK (RESCUE, PUMPER, ETC): _____

BRAND OF TRUCK: _____

RURAL OR CITY: _____

LONG SET BACKS: YES NO

LIGHT TOWER IN FLEET: YES NO

EMAIL: _____

PHONE: _____



VISIT OUR WEBSITE OR
SCAN TO REQUEST A
CUSTOM FIT-OUT GUIDE



SAFETY SEVEN

HiViz LED Lighting® supplies nearly 600 unique lighting fixtures. For the new-build fire apparatus market, we work with our OEM partners to focus on seven specific product categories. Our goal is for our partners to have these products pre-engineered and available as drop-downs in their preferred quote writing tool. By selecting a part from the Safety Seven on your new apparatus, you can help keep engineering time to a minimum and production schedules on time!

1

HEADLIGHTS

FireTech® headlights are the only headlights specifically designed for use in emergency vehicles and are guaranteed for the life of the apparatus. Better foreground illumination is key and the halo/park lamp helps to give a modern look and feel to a traditionally less exciting part of the truck.



2

BAR STYLE FIXTURES

The FireTech brow lights are the keystone in our product range. As the first fixtures designed specifically for the leading edge of an apparatus cab, these scene lights streamline the look of your apparatus and combine up to seven traditional fixtures into one.



3

SURFACE & RECESSED SCENE LIGHTS

There are a range of options for your side scene lighting. Whether it's a surface mounted scene light with asymmetric optics or a bar/recessed style fixture, we have you covered and will help guide you to the correct solution for your apparatus.



4

COMPARTMENT & UNDERCARRIAGE SCENE LIGHTS

The FT-CU-AQX and HD strip compartment lights were designed for 25 years of operation in a variety of working environments. Whether it's under a truck, in a compartment, or up the aerial, these lights are built to last.



5

LIGHT TOWERS

HiViz produces lights for both The Will-Burt Company and Command Light. Instead of using lights that are designed to be body-mounted, which have incorrect optics, these products are specifically designed to be mounted on a tower.



6

POLE LIGHTS

Proper elevation is the key to reducing glare on the fire scene. Whether you're mounting lights to a pole or a tripod, HiViz has you covered. We have lighting options ranging from 10k to 30k of raw lumen output, AC or DC power, switch or no switch, and a housing profile to suit any space.



7

WORK LIGHTS

FireTech work lights are great choices for rear work area, hose bed, and aerial tip applications where NFPA 1901 compliance is a must. Our photometric data are always available upon request.

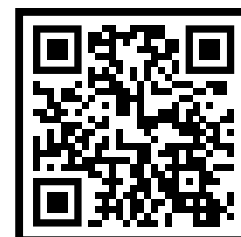

VISIT OUR WEBSITE TO VIEW ALL OF OUR PRODUCTS

BLACKOUT LED LIGHTS

We've all seen the trend...murdered out fire apparatus are here to stay! The FireTech® brand has a large selection of blackout fixtures specifically designed for these applications!



 FIRETECH 4X6 HEADLIGHTS | PG. 16

 FIRETECH BROW LIGHTS | PG. 28

 GUARDIAN® SCENE LIGHT | PG. 36

 GUARDIAN JR SCENE LIGHT | PG. 37

HOW TO CONFIGURE YOUR PART NUMBER

PART NUMBER BREAKDOWN *

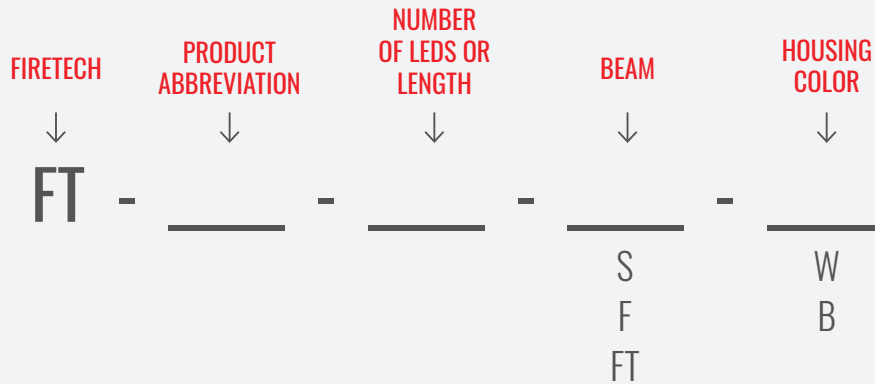

PRODUCT ABBREVIATION

GESM	GUARDIAN ELITE
GSM	GUARDIAN
GSMJR	GUARDIAN JR.
BG2	BG2
B	BROW LIGHT
MB	MINIBROW
SL	POLE MOUNTED
PSL	PATRIOT POLE MOUNTED
WL	WORK LIGHT
WL-X	WORK LIGHT XTREME
CU-HD	COMPARTMENT LIGHT
CU-AQX	UNDERCARRIAGE LIGHT
CSW	SHOCKWAVE
CU-P500	UTILITY LIGHT
P48	PAR 46

NUMBER OF LEDS OR LENGTH

Number will vary depending on product; please see individual product page or visit our website to select which size or LED amount is right for you.

HOUSING COLOR OPTIONS *

W=WHITE



B=BLACK



AVAILABLE BEAM PATTERNS *



S=SPOT
LONG DISTANCE



F=FLOOD
AMPLE COVERAGE



FT=FIREFTECH OPTICS
BEST OF BOTH

EXAMPLE OF CONFIGURED PART NUMBER

FT-MB-33-S-W

(MINIBROW - 33 LED - SPOT - WHITE)

* Not all products have each of these options available. For more details please refer to the individual product page or our website to configure your exact part number.

HEADLIGHTS





FireTech® headlights are the only headlights specifically designed for use in emergency vehicles and are guaranteed for the life of the apparatus. Better foreground illumination is key and the halo/park lamp helps to give a modern look and feel to a traditionally less exciting part of the truck.

4X6 HEADLIGHTS

PURPOSE BUILT FOR EMERGENCY VEHICLES



KEY FEATURES

- Direct Replacement for Existing Headlights
- Integrated Halo/Park Lamp
- DOT/FMVSS 108 Compliant

DOT COMPLIANT HEADLIGHT FUNCTIONS (4 PIECE KIT EXAMPLE)

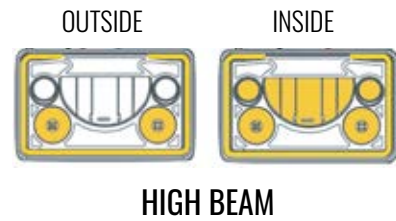
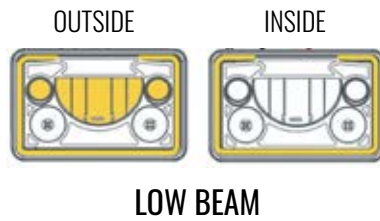
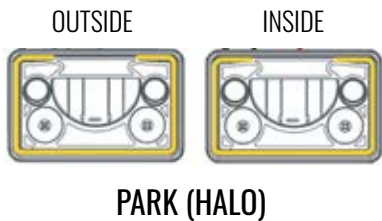

DESIGNED FOR EMERGENCY SERVICES

FireTech® LED headlights are a simple way to dramatically boost the total light output of your emergency vehicle. Utilizing long range IRIS Reflector technology, the FireTech LED headlight is able to push the light from the high beam LEDs to surprising distances, while the reflector for the low beam LED was engineered to produce a wide beam pattern to cover the entire roadway. Each beam is precisely positioned to keep light out of the eyes of traffic, ensuring drivers are unimpaired from the light. Two elliptical beam LEDs in each headlight are aimed to fill in the roadway right in front and to the sides of the vehicle, increasing safety while driving and on scene.

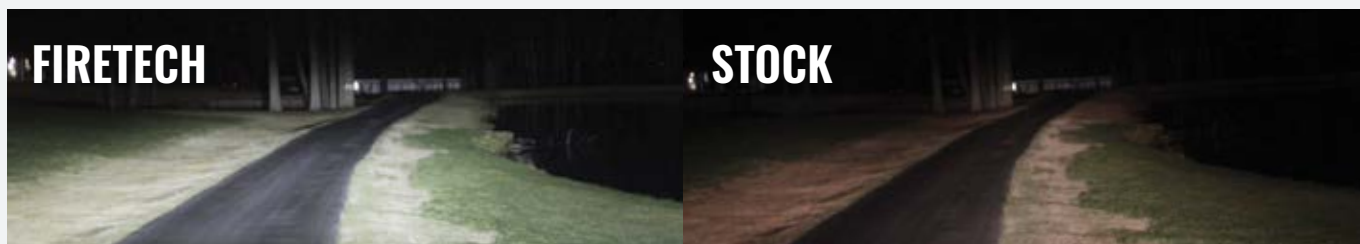



NEW HEATED 4X6 HEADLIGHT

The FireTech heated LED headlights utilize a heated glass lens which is around 7X more thermally conductive than polycarbonate or other plastics. This lens allows more heat transfer from the heating element to the surface of the lens, which results in faster and more efficient headlight defrosting. The heating element is temperature activated, which prevents it from wearing out during warmer weather conditions. With its durable silver heating element, the headlight is designed for repetitious high temperature cycles in extreme environments.

4X6 HEADLIGHT DIMENSIONS

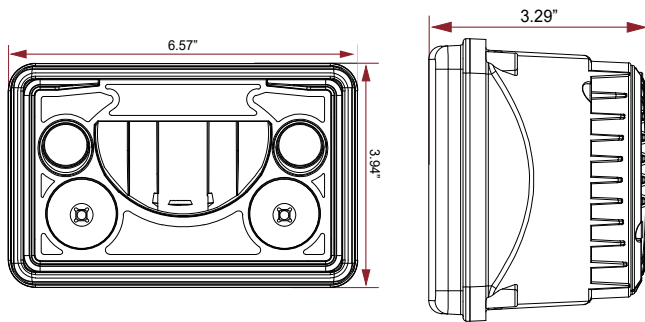

4X6 HEADLIGHTS

USABLE LIGHT	1,000 FEET
REFLECTOR COLORS	CHROME, BLACK CHROME
BEAM MODELS	HIGH/LOW, HALO, HIGH ONLY
DIMENSIONS	6.57" x 3.94" x 3.29"
INPUT VOLTAGE DC	9-32V DC
OPERATING RANGE	-40°F TO +185°F
EMC APPROVAL	CISPR25 CLASS 1
VIBRATION RATING	21.2 G _{RMS}
IP RATING	IP68/69K

MODELS

ITEM #	DESCRIPTION
FT-4X6-HL	4X6 Headlight DOT High / Low (For Low Beam Use); 35W; 2.92A @ 12V DC
FT-4X6-HL-DB	4X6 Headlight DOT High / Low (For Low Beam Use), Black Chrome; 35W; 2.92A @ 12V DC
FT-4X6-H	4X6 Headlight DOT High Beam Only; 41W; 3.42A @ 12V DC
FT-4X6-4KIT	4X6 Kit Containing 4 Headlights: 2 High/Low & 2 High Only; 152W; 12.67A @ 12V DC
FT-4X6-4KIT-DB	4X6 Kit Containing 4 Headlights: 2 High/Low & 2 High Only, Black Chrome; 152W; 12.67A @ 12V DC
FT-4X6-HL-KIT	4X6 Kit Containing 2 High / Low Headlights; 70W; 5.83A @ 12V DC
FT-4X6-HL-DF	Heated 4X6 Headlight DOT High / Low (For Low Beam Use); 58W; 4.84A @ 12V DC
FT-4X6-H-DF	Heated 4X6 Headlight DOT High Beam Only; 64W; 5.37A @ 12V DC
FT-4X6-4KIT-DF	Heated 4X6 Kit Containing 4 Headlights: 2 High / Low & 2 High Only; 244W; 20.42A @ 12V DC
FT-4X6-HL-KIT-DF	Heated 4X6 Kit Containing 2 High / Low Headlights; 116W; 9.68A @ 12V DC



5.75" & 7" HEADLIGHTS

PURPOSE BUILT FOR EMERGENCY VEHICLES



KEY FEATURES

- Direct Replacement
- Integrated Park Lamp Halo
- FMVSS 108 / DOT Compliant

DOT COMPLIANT HEADLIGHT FUNCTIONS (4 PIECE KIT EXAMPLE)

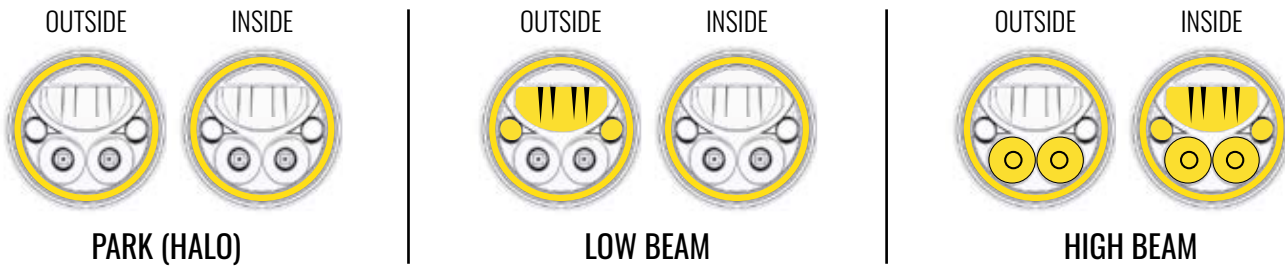

5.75" HEADLIGHT DIMENSIONS

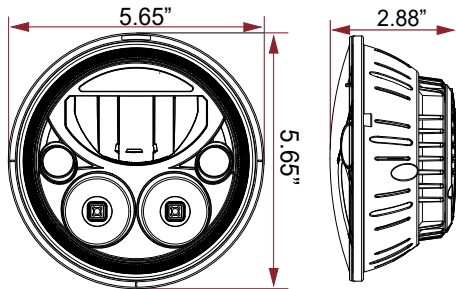

5.75" HEADLIGHTS

RAW LUMENS	4,210/EA
BEAM MODELS	HIGH/LOW, HALO, HIGH ONLY
DIMENSIONS	5.65" x 5.65" x 2.88"
WATTAGE	41W
AMP DRAW (@12V)	3.42A
INPUT VOLTAGE DC	9-32V DC

7" HEADLIGHT DIMENSIONS

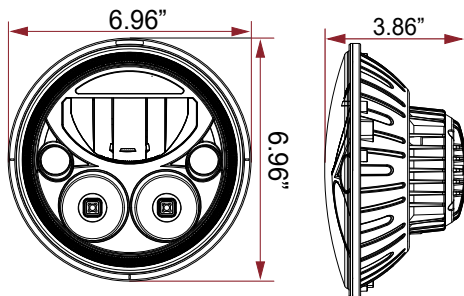

7" HEADLIGHTS

RAW LUMENS	4,210/EA
BEAM MODELS	HIGH/LOW, HALO, HIGH ONLY
DIMENSIONS	6.96" x 6.96" x 3.86"
WATTAGE	37W
AMP DRAW (@12V)	2.92A
INPUT VOLTAGE DC	9-32V DC

LEARN MORE ABOUT
FIRETECH HEADLIGHTS



MODELS

ITEM #	DESCRIPTION
FT-575RD-H	5.75" Headlight DOT High Only; 34.2W; 2.67A @ 12V DC
FT-575RD-HL	5.75" Headlight DOT High / Low (For Low Beam Use); 30.2W; 2.35A @ 12V DC
FT-575RD-HL-KIT	5.75" Kit Containing 2 High / Low Headlights; 60.4W; 4.7A @ 12V DC
FT-575RD-4KIT	5.75" Kit Containing 4 Headlights, 2 High/Low and 2 High Only; 128.8W; 10.04A @ 12V DC
FT-575RD-H-MOUNT	Mounting Kit for 5.75" Headlight DOT High Only; 34.2W; 2.67A @ 12V DC
FT-575RD-HL-MOUNT	Mounting Kit for 5.75" Headlight DOT High / Low (For Low Beam Use); 30.2W; 2.35A @ 12V DC
FT-575RD-HL-KIT-MOUNT	Mounting Kit for 5.75" Kit Containing 2 High / Low Headlights; 60.4W; 4.7A @ 12V DC
FT-575RD-4KIT-MOUNT	Mounting Kit for 5.75" Kit Containing 4 Headlights, 2 High/Low and 2 High Only; 128.8W; 10.04A @ 12V DC
FT-7RD-HL	7" Headlight DOT High / Low (For Low Beam Use); 47W; 3.67A @ 12V DC
FT-7RD-HL-KIT	7" Headlight Kit of 2 DOT High / Low (For Low Beam Use); 94W; 7.34A @ 12V DC

BRACKETS
REQUIRED TO
MOUNT ON
PIERCE CABS

BAR STYLE FIXTURES





FireTech® bar style fixtures are the ultimate lighting solution for the front of your fire apparatus. Featuring spot, flood, and scene optics, they have the power to illuminate anything in the apparatus' path.

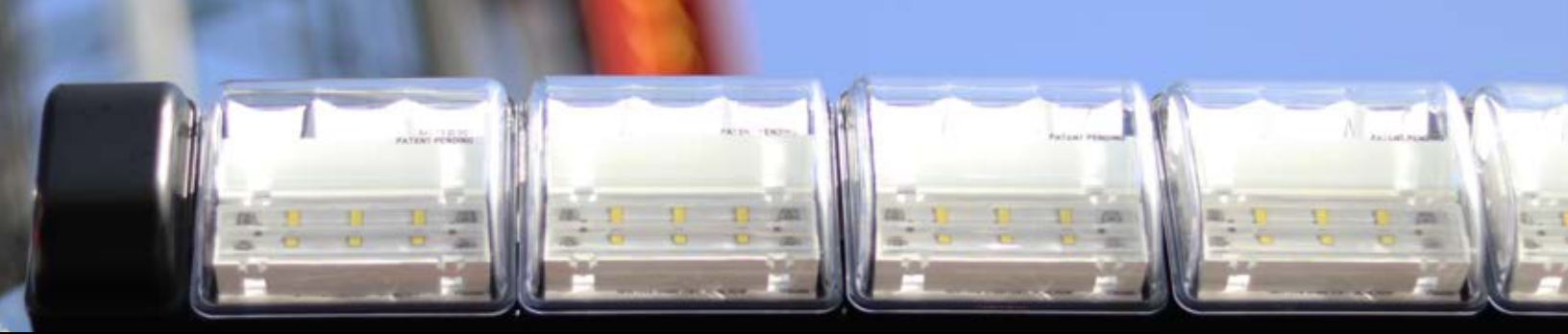

BG2 MODULAR LIGHT SYSTEM

REVOLUTIONARY MODULAR LIGHTING TECHNOLOGY



BG2 KEY FEATURES AND OPTIONS

The race for the most light is over. In today's digitally connected world full of distracted drivers, it's more important to use the right type of light in only the correct areas. Too much light can be blinding, and too little light prevents you from getting your job done. With the BG2, every module has the ability to engage spot, flood, scene, or colored lights independently. This means you can focus on the big picture of the scene and control the white lighting, warning lighting, and traffic director functions from one interconnected system.

MARKER, TRAFFIC, AND WARNING LIGHT CONFIGURATION OPTIONS

Each BG2 module has the option to add a color circuit with either amber, red or blue LEDs. This independent circuit can be programmed to function as a traditional marker light, a dynamic traffic director, or as a warning light.

MARKER LIGHT



TRAFFIC DIRECTOR



OR

WARNING LIGHT



DIMENSIONS

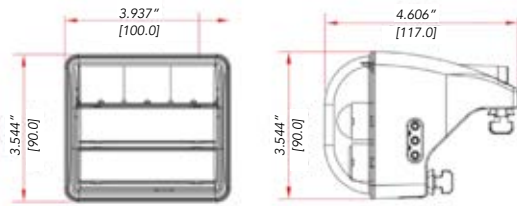

BG2 4" MODULE	
VOLTAGE RANGE	9-32V DC
MAX POWER CONSUMPTION	32 WATTS
RAW LUMENS PER MODULE	3,400
OPERATING TEMP. RANGE	-40°C TO 60°C
INGRESS PROTECTION RATING	IP67/69K
DIMENSIONS	3.544" x 3.937" x 4.606"

EXPANDABLE MODULAR DESIGN

The building block and backbone for this system is a 4" wide light module with a variety of circuits packed inside. Each module is attached to a custom extrusion and shares power through our innovative bridging pin connectors. The modular design allows for sizes ranging from a single module wide up to the full length of the apparatus.



CUSTOM TOOLED MOUNTING BRACKET FOR ANY CAB

The key to minimizing shadowing is correct placement on the apparatus. With BG2, a custom-tooled extrusion is matched to the installation location, which results in optimal placement on the edge of the apparatus body. No fabricating, cutting, or thinking are required. Just choose the correct extrusion, mount the track, and send the truck down the road. Choose your chassis brand:

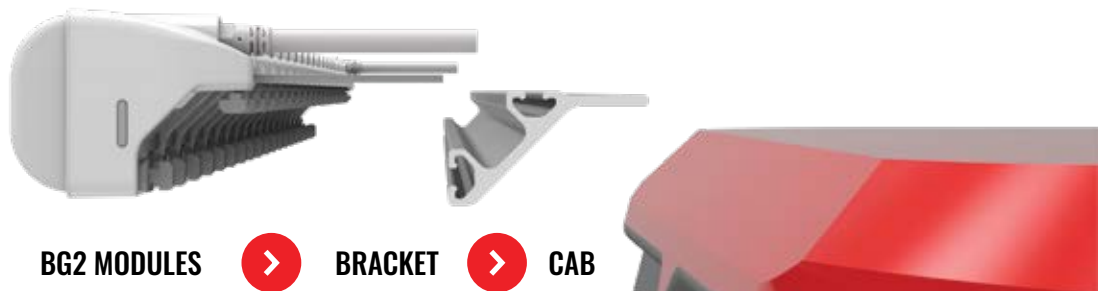

BG2 MODULES



BRACKET



CAB



BG2 LIGHTING FEATURES

CUSTOMIZABLE LIGHTING CONFIGURATIONS

SPOT / FLOOD / SCENE LIGHT

All BG2 modules come standard with three different beam patterns that are equipped with white LEDs and can be controlled independently.

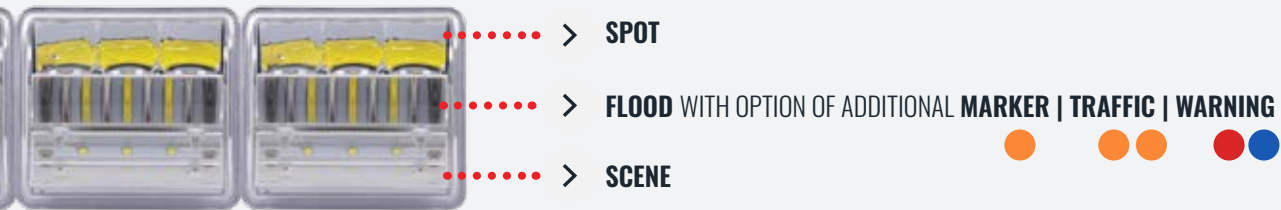

MARKER LIGHT OPTION

Add an additional circuit with amber LEDs to select modules to function as marker lights (available with all BG2 lighting packages).



TRAFFIC DIRECTOR OPTION

Add an array of amber LED circuits to your BG2 to create a synchronized traffic indicator across a single (Smart) or multiple (Smart Multi-System) BG2 light fixtures (available with Smart and Smart Multi-System BG2 lighting packages).

OR



WARNING LIGHT OPTION

Add an array of colored (red, blue, or amber) LED circuits to your BG2 to create a synchronized warning light across a single (Smart) or multiple (Smart Multi-System) BG2 light fixtures (available with Smart and Smart Multi-System BG2 lighting packages).

GLOW MODE

Engages the scene BG2 lighting circuit to produce a soft, downward facing glow that is suitable for non-mission critical service calls (available on any smart fixture or system).

GO MODE

Engages spot, flood, and scene BG2 lighting circuits simultaneously with MAX intensity that is suitable for mission critical service calls (available on any smart fixture or system).

CRUISE MODE

Engages colored LED circuit only with low-intensity (available with Multi-System BG2 Package only).

CONTROLLER OPTIONS:

4 TOGGLE WIRES

Raw lead wires control each of the spot, flood, scene and marker light circuits.

SMART STANDALONE CONTROLLER

Independently controls a single BG2 scene light with 12 pre-configured modes and integrates into your OEM electrical system.

CENTRAL SYSTEM MANAGER

Upgraded controller links multiple BG2 scene lights to be controlled simultaneously with 100+ user mode options; integrates into your OEM electrical system.

USER INTERFACE PANEL

Completely independent control panel with the same features as the Central System Manager without having to integrate into OEM electrical system.

ULTIMATE CONTROL

USER INTERFACE PANEL

- » Eliminates hassle of apparatus electrical integration.
- » Quickly change between all lighting modes across multiple fixtures.
- » Sync multiple panels together for easy-access control locations.

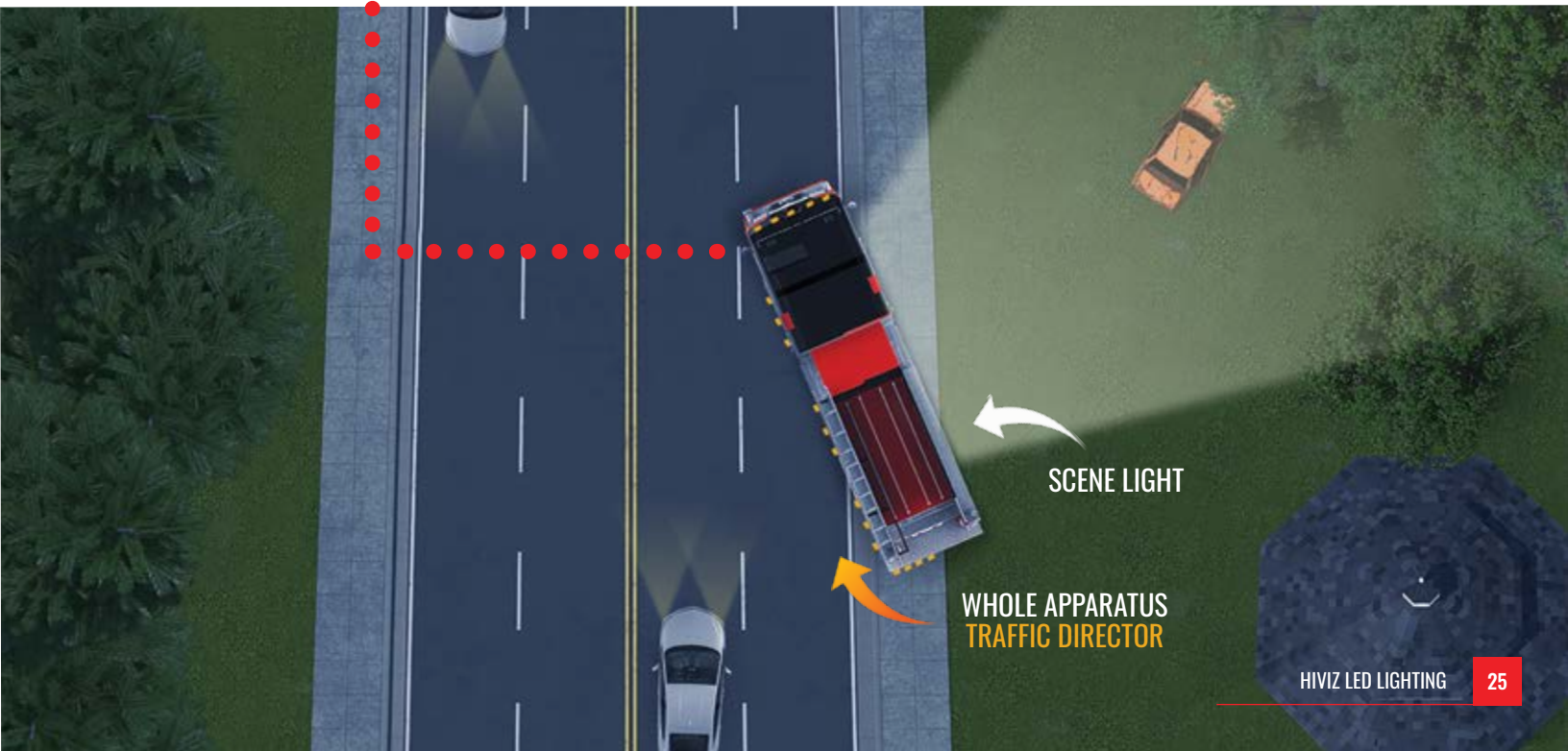
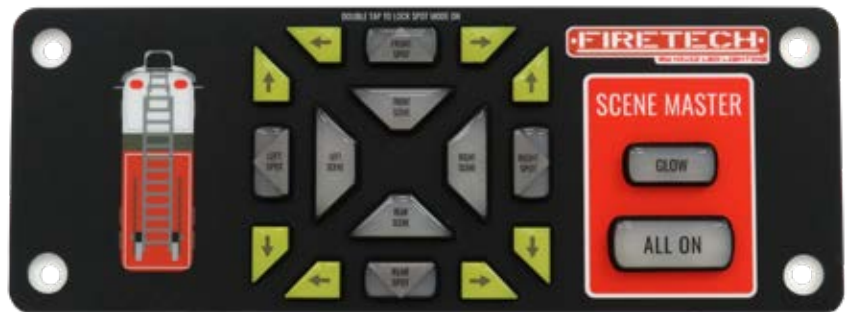

CHOOSING YOUR BG2 LIGHTS

STANDARD

BG2 SCENE LIGHT

LIGHTING FEATURES:

- ✓ SPOT / FLOOD / SCENE LIGHT
- ✓ MARKER LIGHT OPTION

FUNCTIONALITY:

- ✓ TRADITIONAL SCENE LIGHT

CONTROLLER:

- ✓ (4) TOGGLE WIRES

SMART

ADVANCED LIGHTING FEATURES
WITH MORE CONTROL
(1 Fixture)

LIGHTING FEATURES:

- ✓ SPOT / FLOOD / SCENE LIGHT
- ✓ MARKER LIGHT OPTION
- ✓ WARNING LIGHT OPTION
- ✓ TRAFFIC DIRECTOR OPTION
- ✓ GLOW MODE
- ✓ GO MODE

FUNCTIONALITY:

- ✓ TRADITIONAL SCENE LIGHT
- ✓ 12 PRECONFIGURED MODES

CONTROLLER:

- ✓ (1) STAND ALONE
CONTROLLER PER BG2

SMART MULTI-SYSTEM

COMPLETE LIGHTING
SYSTEM WITH MAXIMUM
CONTROL AND FUNCTIONALITY
(2+ Fixtures)

LIGHTING FEATURES:

- ✓ SPOT / FLOOD / SCENE LIGHT
- ✓ MARKER LIGHT OPTION
- ✓ WARNING LIGHT OPTION
- ✓ TRAFFIC DIRECTOR OPTION
- ✓ GLOW MODE
- ✓ GO MODE
- ✓ CRUISE MODE

FUNCTIONALITY:

- ✓ TRADITIONAL SCENE LIGHT
- ✓ USER CONFIGURED MODES
- ✓ MULTI-LINK FIXTURES

CONTROLLER:

- ✓ CENTRAL SYSTEM MANAGER
FOR MULTIPLE BG2s
- ✓ USER INTERFACE PANEL
OPTION

ORDERING YOUR BG2 LIGHTS



STEP 1.

Visit HIVIZLEDS.COM to launch configurator

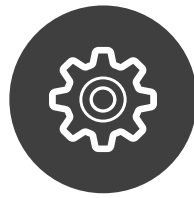

STEP 2.

Configure your BG2 lighting system



STEP 3.

Download engineering and spec files



STEP 4.

Share configuration serial# with apparatus manufacturer / system integrator

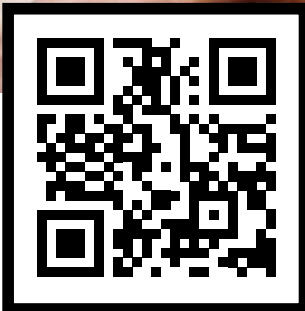

SCAN TO BUILD YOUR BG2

USING OUR ONLINE CUSTOM CONFIGURATOR TOOL



BROW LIGHTS

4"-75" LOW PROFILE LIGHT FIXTURES



KEY FEATURES

- **OPTIONAL MARKER LIGHTS (DOT COMPLIANT)**
Each FireTech Brow Light has the option of integrated DOT compliant marker lights. These allow you to combine six to seven fixtures into one, while maintaining DOT compliance.
- **ADJUSTABLE MOUNTS ALONG BODY**
Using our patented rail mounting foot, the FireTech brow lights can be securely attached to the cab every 12-18 inches, preventing the housing from flexing and preserving fixture integrity over time.
- **ALL ALUMINUM CONSTRUCTION**
FireTech Brow Lights are manufactured from a solid billet of aluminum which offers superior structural rigidity and thermal dissipation.

DOMINATE THE SCENE WITH FIVE LIGHTS IN ONE

FireTech® Brow Lights give you the right type of lighting for the leading edge of your apparatus cab. By combining a long distance spot beam with multiple flood beams, your apparatus will have both range and coverage.

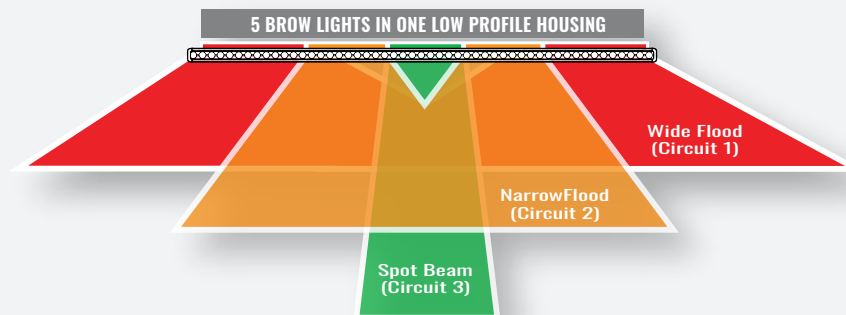

STANDARD BROW LIGHT MODELS

FT-B-46-* | 36 LEDES | 19,008 RAW LM



FT-B-54-2PKIT-* | 42 LEDES | 22,176 RAW LM



FT-B-65-* | 51 LEDES | 26,928 RAW LM



FT-B-72-* | 57 LEDES | 30,096 RAW LM



FT-B-72-3PKIT-* | 57 LEDES | 30,096 RAW LM



MARKER BROW LIGHT MODELS

FT-B-46-ML-* | 35 LEDES | 15,840 RAW LM



FT-B-46-ML3-* | 39 LEDES | 19,008 RAW LM



FT-B-72-ML-* | 59 LEDES | 28,512 RAW LM 80" AVAILABLE ON REQUEST FOR EXTRA LARGE CABS



FT-B-72-ML-3PKIT-* | 59 LEDES | 28,512 RAW LM



DIMENSIONS

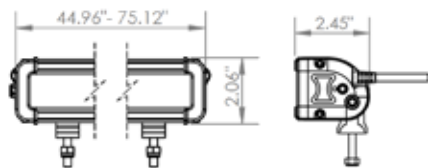

ITEM #	DESCRIPTION	ACTUAL LENGTH
FT-B-46-ML-*	46" Brow Light, 5 integrated marker lights, 4 circuits	44.96"/1,142.40mm
FT-B-46-ML3-*	46" Brow Light, 3 integrated marker lights, 4 circuits	50.01"/1,270.25mm
FT-B-54-2PKIT-*	2 Piece 54" Brow Light, single circuit for aerials	2x 27.33"
FT-B-65-*	65" Brow Light, 3 circuits	65.23"/1,656.80mm
FT-B-72-*	72" Brow Light, 3 circuits	72.69"/1,846.33mm
FT-B-72-ML-*	72" Brow Light, 5 integrated marker lights, 4 circuits	75.12"/1,908.05mm
FT-B-72-ML-3PKIT-*	3 Piece 72" Brow Light with marker lights for radiused cabs	1x 27.32" 2x 24.8"
FT-B-72-3PKIT-*	3 Piece 72" Brow Light for radiused cabs	1x 27.32" 2x 23.52"

SINGLE STACK MINIBROW®

4"-50" MINIBROW SCENE LIGHTS



KEY FEATURES

- Ultra Low Profile Design
- Configurable Optics
- Adjustable Mounting Rail

MODELS

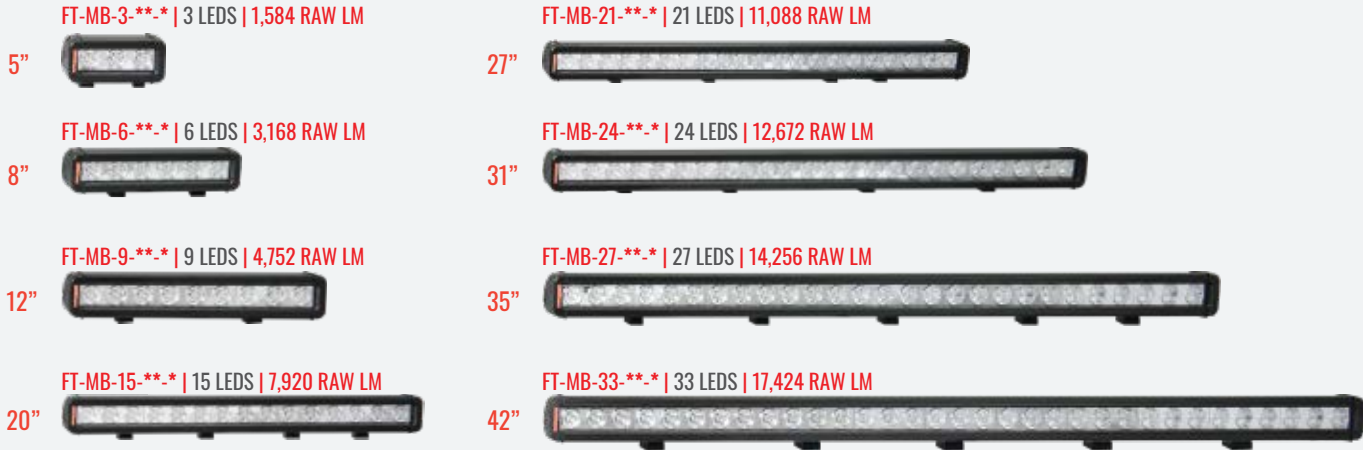

DIMENSIONS

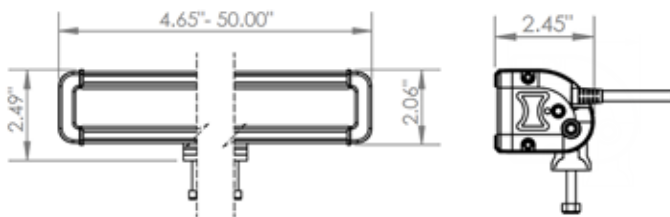

ITEM #	ACTUAL LENGTH	WATTS	AMP DRAW
FT-MB-3-**-*	4.65"	15	1.25
FT-MB-6-**-*	8.43"	30	2.5
FT-MB-9-**-*	12.21"	45	3.75
FT-MB-15-**-*	19.77"	75	6.25
FT-MB-21-**-*	27.33"	105	8.75
FT-MB-24-**-*	31.11"	120	10
FT-MB-27-**-*	34.89"	135	11.25
FT-MB-33-**-*	42.44"	165	13.75
FT-MB-39-**-*	50.00"	195	16.25



DOUBLE STACK MINIBROW®

4"-50" MINIBROW SCENE LIGHTS



KEY FEATURES

- Two Rows of LEDs
- Configurable Optics
- Adjustable Mounting Rail

DIMENSIONS

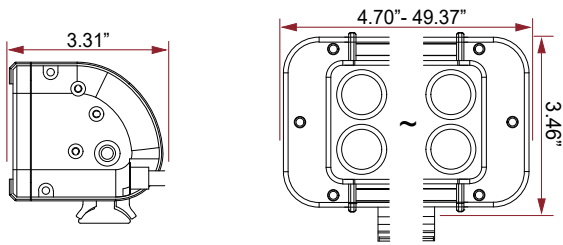

ITEM #	ACTUAL LENGTH	WATTS	AMP DRAW
FT-MB-2.3-**-*	4.70"	30	2.5
FT-MB-2.6-**-*	7.90"	60	5
FT-MB-2.9-**-*	11.10"	90	7.5
FT-MB-2.15-**-*	17.50"	150	12.5
FT-MB-2.18-**-*	20.60"	180	15
FT-MB-2.27-**-*	30.20"	270	22.5
FT-MB-2.36-**-*	39.80"	360	30
FT-MB-2.45-**-*	49.37"	450	37.5

MODELS

FT-MB-2.3-**-* | 6 LEDs | 3,168 RAW LM



FT-MB-2.6-**-* | 12 LEDs | 6,336 RAW LM



FT-MB-2.9-**-* | 18 LEDs | 9,504 RAW LM



FT-MB-2.15-**-* | 30 LEDs | 15,840 RAW LM



FT-MB-2.18-**-* | 36 LEDs | 19,008 RAW LM



FT-MB-2.27-**-* | 54 LEDs | 28,512 RAW LM



FT-MB-2.36-**-* | 72 LEDs | 38,016 RAW LM



FT-MB-2.45-**-* | 90 LEDs | 47,520 RAW LM





TRUNNION MINIBROW®

14"-31" MINIBROW SCENE LIGHTS



KEY FEATURES

- Ultra Low Profile Design
- Configurable Optics
- Adjustable Mounting Rail

MODELS

FT-MB-9-TR-**-* | 9 LEDs | 4,752 RAW LM



FT-MB-12-TR-**-* | 12 LEDs | 6,336 RAW LM



FT-MB-18-TR-**-* | 18 LEDs | 9,504 RAW LM



FT-MB-24-**-*-GWA0011 | 24 LEDs | 12,672 RAW LM



NOTE: The "TRGWA" style Trunion is only Available on FT-MB-24 Model

60 POINT LOCKING AIMING SYSTEM

The sturdy trunion bracket allows the MiniBrow to be precisely aimed regardless of mounting location. Enjoy full rotation flexibility from an ultra low profile housing.

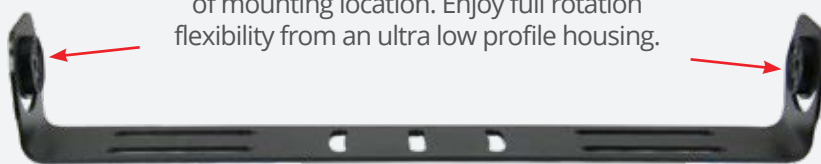

DIMENSIONS

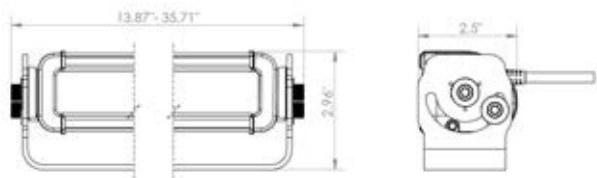

ITEM #	LENGTH	WATTS	AMP DRAW
FT-MB-9-TR-**-*	13.87"	45	3.75
FT-MB-12-TR-**-*	17.65"	60	5.0
FT-MB-18-TR-**-*	25.20"	90	7.5
FT-MB-24-**-*-GWA0011	31.11"	120	10.0

MOUNTING ACCESSORIES

OPTIONS FOR YOUR LIGHT BARS

INCLUDED MOUNTING ACCESSORY



In order to maximize the light on scene, mount your MiniBrow® as close to the edge of the cab or body as practicable and tilt 5-10 degrees down from perpendicular to the roadway.

We recommend using FireTech combination optics on the side of the truck cab and flood optics on the side and rear of the body.

OPTIONAL MOUNTING ACCESSORIES

CAB MOUNTING BRACKET | 3" RADIUS SURFACE

For use with any brow light

BLACK: P-MB-R3V2FOOT-B
WHITE: P-MB-R3V2FOOT-W

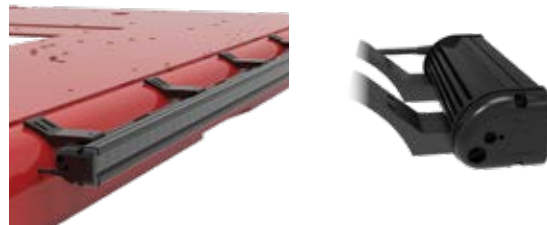

L-FOOT BRACKET | VERTICAL SURFACE

For use with any brow light

BLACK: P-MB-LFOOT-B
WHITE: P-MB-LFOOT-W

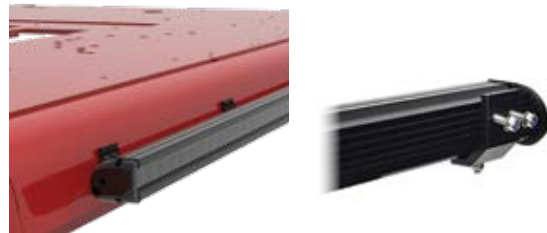

END CAP BRACKET | FLAT SURFACE

For use with brow lights 36" or less only

MINIBROW BLACK: FT-MBKIT-LPX-B
MINIBROW WHITE: FT-MBKIT-LPX-W
DOUBLE MINIBROW BLACK: FT-MBKIT-PX-B
DOUBLE MINIBROW WHITE: FT-MBKIT-PX-W



SURFACE AND RECESSED SCENE LIGHTS





Ever since our entry into the fire market in 2011, our customers have been asking for a cost-effective surface mounted LED scene light and we answered in a big and bright way.

GUARDIAN® SERIES

SURFACE MOUNTED SCENE LIGHTS



KEY FEATURES

- Industry Standard Sizes
- Multiple Output Options
- Widespread Precision Optics

MORE LIGHT, LESS POWER

The Guardian Elite produces as much measurable light as other fixtures in the fire industry that advertise 20,000 lumens of output. However, the Guardian Elite produces that light using close to 90 watts (7.5A) LESS power per fixture, at 12V DC. What does this mean for you? In the world of modern electronics, the capacity of the 12V chassis electrical system is often quickly consumed. When building a truck with lots of DC loads, you will be less likely to experience amperage load chart or electrical system limitations due to the scene lighting package using an ultra-efficient fixture like the FireTech Guardian Elite!

Less Power = Less Heat. By keeping the circuit temperature low, the FireTech Guardian Series can offer sustained light output regardless of runtime on your incident.

GUARDIAN OPTIONAL ACCESSORIES



RETROFIT GASKET
P/N: P-GSM-RGKIT

For replacing older style fixture or halogen side scene light. Covers old or oversized holes in the body.



BEZEL DELETE GASKET
P/N: P-GSM-BDKIT

Allows installation of Guardian/Guardian Elite Scene Light without chrome bezel for a reduced mounting profile.

DIMENSIONS FOR GUARDIAN® AND GUARDIAN ELITE

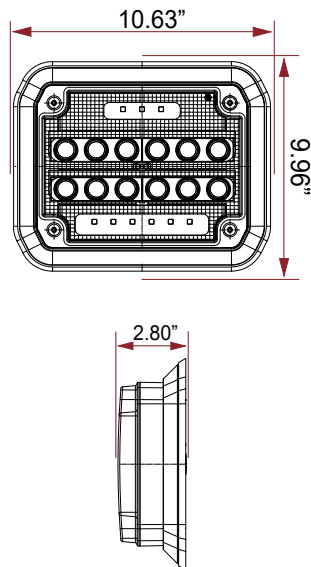

GUARDIAN | STANDARD OUTPUT

RAW LUMENS	10,000
EFFECTIVE LUMENS	6,500
OPT. HOUSING COLORS	BLACK OR CHROME
WATTAGE	75W
AMP DRAW (@12V)	5.83A
INPUT VOLTAGE DC	9-32V DC

GUARDIAN ELITE | HIGH OUTPUT

RAW LUMENS	20,500
EFFECTIVE LUMENS	12,290
OPT. HOUSING COLORS	BLACK
WATTAGE	120W
AMP DRAW (@12V)	10.41A
INPUT VOLTAGE DC	9-32V DC

DIMENSIONS FOR GUARDIAN JR

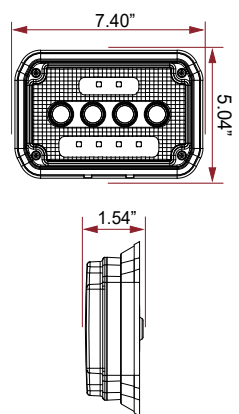

GUARDIAN JR | STANDARD OUTPUT

LEDS	10 CREE
RAW LUMENS	5,000
EFFECTIVE LUMENS	3,125
OPT. HOUSING COLORS	BLACK OR CHROME
DIMENSIONS	7.40" x 5.04" x 1.54"
WATTAGE	35W
AMP DRAW (@12V)	3.33A
INPUT VOLTAGE DC	9-32V DC

MODELS

ITEM #	DESCRIPTION
FT-GSM	Guardian LED Surface Mount: 10K lm, DC Power, 75W, Chrome
FT-GSM-B	Guardian LED Surface Mount: 10K lm, DC Power, 75W, Black
FT-GSM-W	Guardian LED Surface Mount: 10K lm, DC Power, 75W, White
FT-GESM	Guardian Elite LED Surface Mount: 20.5K lm, DC Power, 120W, Chrome
FT-GESM-B	Guardian Elite LED Surface Mount: 20.5K lm, DC Power, 120W, Black
FT-GESM-W	Guardian Elite LED Surface Mount: 20.5K lm, DC Power, 120W, White
FT-GSMJR	Guardian Jr. LED Surface Mount: 5K lm, DC Power, 35W, Chrome
FT-GSMJR-B	Guardian Jr. LED Surface Mount: 5K lm, DC Power, 35W, Black

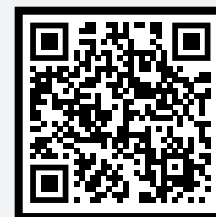

**HOW TO INSTALL
THE GUARDIAN**



SEMI-RECESSED / RECESSED

FIXED AND ADJUSTABLE SCENE LIGHTS



FT-MB-2.15--**-CPREC**
 ** -OPTICS (S, F, FT) * -HOUSING COLOR (B, W)

DIMENSIONS

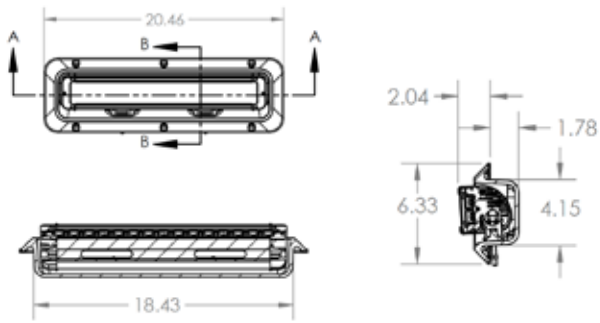

KEY FEATURES

- Requires Less Than 2.5" Mounting Depth
- Multiple Output Options
- Wide Spread Precision Optics

SEMI-RECESSED SCENE LIGHT

LEDS	30 X 5W CREE
RAW LUMENS	15,840
EFFECTIVE LUMENS	11,880
OPT. HOUSING COLORS	BLACK OR CHROME
OPT. BEAM PATTERNS	SPOT, FLOOD, COMBO
DIMENSIONS	20.46" x 6.33" x 3.82"
WATTAGE	150W
AMP DRAW (@12V)	12.5A
INPUT VOLTAGE DC	9-32V DC
EMC APPROVAL	CISPR25 CLASS 1 / CE
VIBRATION RATING	21.2 G _{RMS}

SEMI-RECESSED SCENE LIGHT

The FireTech® FT-MB-2.15-**-**-CPREC is a 150 Watt Semi-Recessed FireTech Double Stack MiniBrow light. This fixture mounts easily to the side of your apparatus and maintains the fixture's native adjustability. Once it's installed, just aim the light where you need it and lock down the mounting feet. The FT-MB-2.15-CPREC is the perfect addition to the side of any apparatus, new or old.



FULL RECESSED DOUBLE STACKED MINIBROW | FT-MB-2.18-REC-**-*

FULLY RECESSED; STICKS OUT LESS THAN 1/4"



FT-MB-2.18-REC--***
**-OPTICS (S, F, FT) *-HOUSING COLOR (B, W)

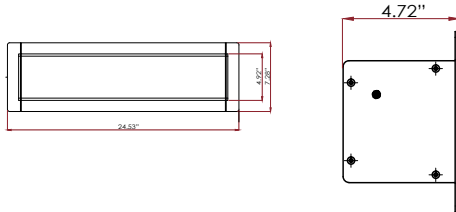

RECESSED DOUBLE STACKED MINIBROW

LEDS	36 X 5W CREE
RAW LUMENS	19,008
EFFECTIVE LUMENS	13,305
OPT. HOUSING COLORS	BLACK OR WHITE
OPT. BEAM PATTERNS	SPOT, FLOOD, COMBO
DIMENSIONS	24.53" x 7.28" x 4.72"
WATTAGE	180W
AMP DRAW (@12V)	15A
INPUT VOLTAGE DC	9-32V DC
CONNECTOR	DEUTSCH DT04-2P
EMC APPROVAL	CISPR25 CLASS 1 / CE
VIBRATION RATING	21.2 G _{RMS}

RECESSED WL-X-9 FIXED & ADJUSTABLE FIXTURES

FIXED MOUNT



GREAT UNDER AERIAL PLATFORMS!

FT-WL-X-9--*-CPREC-FIX**
**-OPTICS (S, F, FT) *-HOUSING COLOR (B, W)

RECESSED WL-X-9 FIXED & ADJUSTABLE

LEDS	9 X 7W CREE
RAW LUMENS	7,200
EFFECTIVE LUMENS	5,734
OPT. HOUSING COLORS	BLACK OR WHITE
OPT. BEAM PATTERNS	SPOT, FLOOD, COMBO
DIMENSIONS	7.74" x 7.73" x 3.22"
WATTAGE	63W
AMP DRAW (@12V)	7A
INPUT VOLTAGE DC	11-65V DC
CONNECTOR	DEUTSCH DT04-2P
EMC APPROVAL	CISPR25 CLASS 1 / CE
VIBRATION RATING	21.2 G _{RMS}

ADJUSTABLE MOUNT



FT-WL-X-9--*-CPREC-ADJ**
**-OPTICS (S, F, FT) *-HOUSING COLOR (B, W)

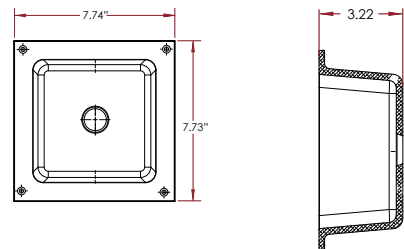

COMPARTMENT AND UNDERCARRIAGE LIGHTS





With FireTech® Compartment & Undercarriage lights, you'll never see sections unhooking from each other or pieces of the light going out. Mount it inside or out, we'll stand behind it forever.

COMPARTMENT & UNDERCARRIAGE

DURABLE AND COMPACT LIGHTS



FT-CU-HD-***
**-LENGTH OF STRIP
*-LED COLOR OPTIONS (RW, RED, BLUE, GREEN)

KEY FEATURES

- Heavy Duty and Ultra Durable
- Ultra Low Profile Design
- LED Color Options Available

DURABLE, SLIM, AND NOW WITH COLORED LEDS

Looking to add more function and style to your new apparatus? We've got you covered! The upgraded HD strip lights are now available with new color LED options that are sure to fit any needs. Choose between a combo red & white LED for more flexibility or a single circuit red, blue, or green output. Completely waterproof, the new HD strip light can be used inside or outside of the apparatus without risk of failure.

MODELS

7.5"	FT-CU-HD7.5-* 9 LEDs 71 EFFECTIVE LM	
12"	FT-CU-HD12-* 21 LEDs 207 EFFECTIVE LM	
24"	FT-CU-HD24-* 48 LEDs 379 EFFECTIVE LM	
36"	FT-CU-HD36-* 75 LEDs 686 EFFECTIVE LM	
48"	FT-CU-HD48-* 96 LEDs 743 EFFECTIVE LM	

SUB-AQUA UNDERCARRIAGE LIGHT | FT-CU-AQX-**-*

SUBMERSIBLE UP TO 100'

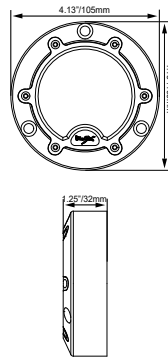

FT-CU-AQX-*
*-HOUSING COLOR (B, W)

SUB-AQUA UNDERCARRIAGE LIGHT

LEDS	6 X 3W
RAW LUMENS	1,500
EFFECTIVE LUMENS	1,050
OPT. HOUSING COLORS	BLACK OR WHITE
OPT. LIGHT COLORS	RED/WHITE OR ALL WHITE
WATTAGE	22W
AMP DRAW (@12V)	1.833A
INPUT VOLTAGE DC	11-32V DC

Available in a Red/White LED Option (use order # FT-CU-AQX-RW-*)
Order P/N FT-CU-AQX-*-KIT for light + mounting bracket

SHOCKWAVE INTERIOR LIGHT | FT-CSW-112-*-**-B

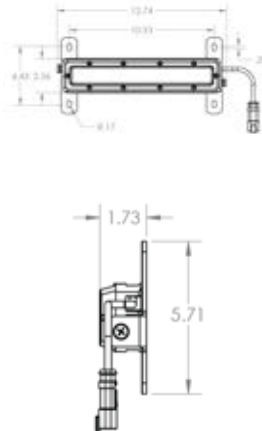

FT-CSW-112-*--B**
*-FROSTED LENS OPTION (F)
**-LED COLOR OPTION (BW)

- ULTRA HIGH OUTPUT INTERIOR LIGHTING
- CUBE SHAPED LEDS PRODUCE 180° OF LIGHT
- DC OR AC OPERATION
- DIMMABLE

SHOCKWAVE INTERIOR LIGHT

LEDS	48 LEDS
RAW LUMENS	1,500
EFFECTIVE LUMENS	1,050
HOUSING COLOR	BLACK
OPT. LIGHT COLORS	BLUE/WHITE OR ALL WHITE
WATTAGE	22W
AMP DRAW (@12V)	1.833A
INPUT VOLTAGE DC	9-32V DC

MULTIPURPOSE WIDE FLOOD UTILITY LIGHT | FT-CU-P500

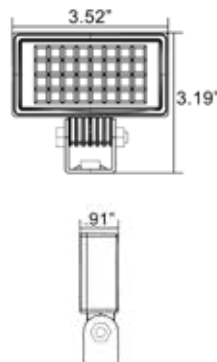

FT-CU-P500

MULTIPURPOSE WIDE FLOOD UTILITY LIGHT

LEDS	32 ULTRA WIDE SMD LEDS
RAW LUMENS	500
EFFECTIVE LUMENS	456
HOUSING COLOR	BLACK
OPT. LIGHT COLORS	WHITE, AMBER, R, G, B
DIMENSIONS	3.19" x 3.52" x 0.91"
WATTAGE	6W
AMP DRAW (@12V)	0.5A
INPUT VOLTAGE DC	9-32V DC

LIGHT TOWERS





We don't make a payload elevator, just the fixtures. We specialize in putting more light on the intended target, while our partners at Will-Burt and Command Light specialize in payload elevation. Reach out to your preferred light tower supplier for more information.



LIGHT TOWER FIXTURES DESIGNED TO PUT MORE LUX ON TARGET



WHY CHOOSE FIRETECH

- Symmetrical optics put more light on target
- Higher luminous efficacy means less energy consumed
- Superior warranty covers you for life
- Available in AC or DC

SHAPE OF LIGHT MATTERS

HiViz LED Lighting® designs purpose-built fixtures for light tower applications. Traditional LED scene lights project light down and out, which works great when fix-mounted to the body of a truck. However, when traditional fixtures are tilted down (like on a light tower), the majority of light generated (lumens) ends up on the roof of the apparatus. If the fixtures are tilted backwards, the down-angled optics end up shining up and the beam ends up totally useless to the firefighter. Choosing FireTech® symmetrical optics on light towers will ensure that every lumen created at the source is converted into useful lux on target.



OTHER MANUFACTURERS' ASYMMETRICAL OPTICS

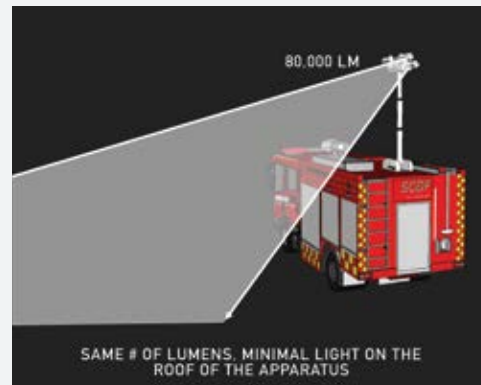

FIRETECH SYMMETRICAL OPTICS



**DOWNLOAD FIRETECH OPTIONS CATALOGS FOR
WILL-BURT AND COMMAND LIGHT TOWERS**



RETROFIT YOUR TOWER

Ask your light tower supplier about retrofitting your existing tower to the latest LED fixtures by HiViz LED Lighting! Virtually any tower can be updated; AC or DC, Will-Burt or Command Light!

POLE LIGHTS





Pole-mounted scene lights are often the most utilized equipment on emergency scenes. Scene lights from FireTech® are well known for packing a big punch while covering a large area.

POLE-MOUNTED LIGHTS

ELEVATION IS THE KEY TO REDUCING GLARE



POLE-MOUNTED GUARDIAN KEY FEATURES

- Compact Size
- Less than 20% Thermal Degradation
- 10k and 20k Equivalent Light Output
- AC or DC Operation

DIMENSIONS

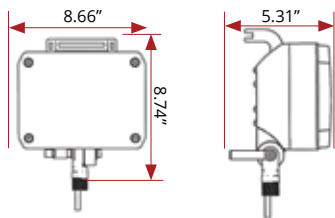

GUARDIAN® | STANDARD OUTPUT

RAW LUMENS	10,000
EFFECTIVE LUMENS	6,500
OPT. HOUSING COLORS	BLACK, CHROME
WATTAGE	75W
AMP DRAW (@12V)	5.83A
INPUT VOLTAGE DC	9-32V DC

GUARDIAN ELITE | HIGH OUTPUT

RAW LUMENS	20,500
EFFECTIVE LUMENS	12,290
OPT. HOUSING COLORS	BLACK
WATTAGE	120W
AMP DRAW (@12V)	10.41A
INPUT VOLTAGE DC	9-32V DC

CONFIGURE PART NUMBER

SWITCH OR NO SWITCH ON BACKPLATE



AVAILABLE OUTPUT AND POWER OPTIONS

GSM= STANDARD GUARDIAN
GESM= GUARDIAN ELITE

“110”
DESIGNATES
90-277V AC POWER
(STANDARD IS 9-32V DC)

(OPT) (OPT)
OUTPUT | INPUT | SWITCH | HOUSING

↓ ↓ ↓ ↓

FT-SL-____ - 110-SW-____

GSM B
GESM W

HOUSING COLOR OPTIONS



EXAMPLE CONFIGURATION

FT-SL-GESM-SW-B

GUARDIAN ELITE SCENE LIGHT - BACK SWITCH
9-32V DC INPUT - BLACK HOUSING

20,000 RAW LUMEN LED SCENE LIGHT | FT-SL-15 / FT-SL-X-15



KEY FEATURES

- 1,000-1,500W Halogen Replacement
- Optional 28,000 Lumen "X" Version

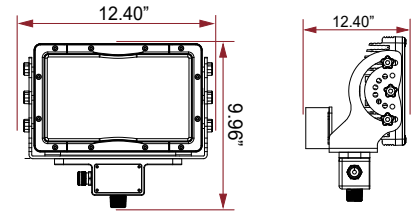

FOR UPGRADED OUTPUT SEE "X" SPECS below

20,000 RAW LUMEN LED SCENE LIGHT

LEDS X	30 X 5W 30 X 7W
RAW LUMENS X	20,000 28,000
EFFECTIVE LUMENS X	11,888 15,305
HOUSING COLOR	BLACK OR WHITE
OPT. BEAM PATTERNS	SPOT, FLOOD, COMBO
DIMENSIONS	11.75" x 7.54" x 4.94"
WATTAGE X	150W 185W
AMP DRAW (@12V)	12.5A 15.4A
INPUT VOLTAGE DC	11-65V DC / 90-277V AC

CONFIGURE PART NUMBER

AVAILABLE OUTPUT AND POWER OPTIONS

"X" DESIGNATES 7W LEDES - HIGH OUTPUT

"110" DESIGNATES 90-277V AC POWER

SWITCH OR NO SWITCH OPTION

"SW" DESIGNATES SWITCH OPTION

HOUSING COLOR OPTIONS

W=WHITE B=BLACK

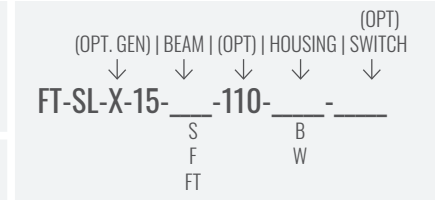

EXAMPLE CONFIGURATION

FT-SL-15-F-110-W-SW

SCENE LIGHT - 30 LED - FLOOD BEAM
 AC POWER MODULE - WHITE HOUSING - SWITCH

30,000 RAW LUMEN LED SCENE LIGHT | FT-SL-30

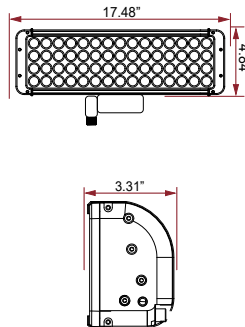

30,000 RAW LUMEN LED SCENE LIGHT

LEDS	60 X 5W
RAW LUMENS	31,680
EFFECTIVE LUMENS	22,200
HOUSING COLOR	BLACK OR WHITE
OPT. BEAM PATTERNS	SPOT, FLOOD, COMBO
DIMENSIONS	17.48" x 4.84" x 3.31"
WATTAGE	300W
AMP DRAW (@12V)	25A
INPUT VOLTAGE DC	11-65V DC

PATRIOT POLE-MOUNTED SCENE LIGHT | FT-PSL

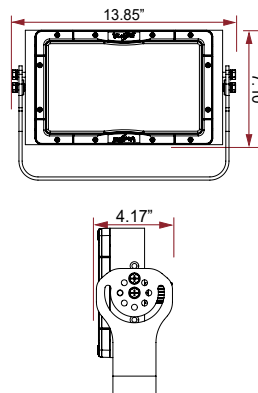

PATRIOT POLE-MOUNTED SCENE LIGHT

LEDS	30
RAW LUMENS DC AC	28,000 31,300
EFFECTIVE LUMENS DC AC	15,305 18,800
HOUSING COLOR	STAINLESS
OPT. BEAM PATTERNS	COMBO
DIMENSIONS	13.85" x 7.10" x 4.17"
WATTAGE DC AC	140W 185W
AMP DRAW (@12V)	15A
INPUT VOLTAGE DC	11-65V DC / 90-277V AC

ITEM

DESCRIPTION

FT-PSL	Patriot Pole-Mounted Scene Light 11-65V DC Input
FT-PSL-110	Patriot Pole-Mounted Scene Light 90-277 AC Input

WORK LIGHTS





FireTech® Work Lights are great choices for rear work areas, hose bed, and aerial tip applications where NFPA compliance is a must. The photometric data sheets of our fixtures are always available upon request.



WORK LIGHTS

HIGH LIGHT OUTPUT, COMPACT DESIGN



FT-WL-X-9--***
**** -OPTICS (S, F, FT) * -HOUSING COLOR (B, W)**

9 LED WORK AND AREA LIGHT

KEY FEATURES

- Compact Size
- Patented thermal technology to prevent overheating
- Can withstand vibration up to 21G_{RMS}
- NFPA compliant at the tip of an aerial

WHY CHOOSE THE WL-X-9?

The FT-WL-X-9 is a 63 watt LED work light designed for use in the fire industry. It meets the minimum NFPA 1901 illumination requirement for a single 12V LED aerial tip light per the 2016 standard. This fixture is designed with our patented intelligent Active Thermal Management LED driver which prevents the circuitry from overheating, regardless of the fixture's operating environment. Like the rest of the FireTech products, the FT-WL-X-9 is backed by our LIFETIME warranty.

DIMENSIONS

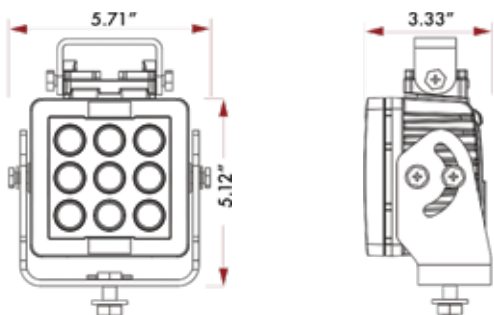

9 LED WORK AND AREA LIGHT

LEDS	9 x 7W
RAW LUMENS	7,200
EFFECTIVE LUMENS	5,734
OPT. HOUSING COLORS	BLACK OR WHITE
OPT. BEAM PATTERNS	SPOT, FLOOD, COMBO
DIMENSIONS	5.71" x 5.12" x 3.33"
BUILT-IN SWITCH	YES
WATTAGE	63W
AMP DRAW (@12V)	5.26A
INPUT VOLTAGE DC	11-65V DC
CONNECTOR	DEUTSCH DTO4-2P
EMC APPROVAL	CISPR25 CLASS 3
VIBRATION RATING	21.2 Grms

9 LED ADJUSTABLE WORK AND AREA LIGHT | FT-WL-X-9-**-*-SH2



FT-WL-X-9--*-SH2**
**-OPTICS (S, F, FT) *-HOUSING COLOR (B, W)

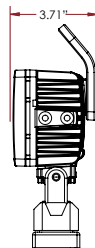
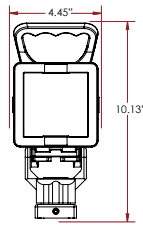

9 LED ADJUSTABLE WORK AND AREA LIGHT

LEDS	9 x 7W
RAW LUMENS	7,200
EFFECTIVE LUMENS	5,734
OPT. HOUSING COLORS	BLACK OR WHITE
OPT. BEAM PATTERNS	SPOT, FLOOD, COMBO
DIMENSIONS	4.45" x 10.13" x 3.71"
BUILT-IN SWITCH	YES
WATTAGE	63W
AMP DRAW (@12V)	5.26A
INPUT VOLTAGE DC	11-65V DC
CONNECTOR	DEUTSCH DT04-2P
EMC APPROVAL	CISPR25 CLASS 3
VIBRATION RATING	21.2 GRMS

20 LED WORK AND AREA LIGHT | FT-WL-X-20-**-*



FT-WL-X-20--***
**-OPTICS (S, F, FT) *-HOUSING COLOR (B, W)

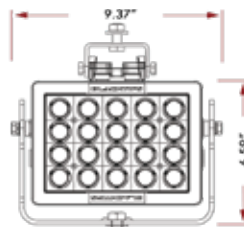

20 LED WORK AND AREA LIGHT

LEDS	20 x 7W
RAW LUMENS	16,000
EFFECTIVE LUMENS	11,270
OPT. HOUSING COLORS	BLACK OR WHITE
OPT. BEAM PATTERNS	SPOT, FLOOD, COMBO
DIMENSIONS	9.37" x 6.59" x 4.13"
BUILT-IN SWITCH	NO
WATTAGE	140W
AMP DRAW (@12V)	11.66A
INPUT VOLTAGE DC	11-65V DC
CONNECTOR	DEUTSCH DT04-2P
EMC APPROVAL	CISPR25 CLASS 3
VIBRATION RATING	21.2 GRMS

12 LED WORK AND AREA LIGHT | FT-WL-X-12-**-*



FT-WL-X-12--***
**-OPTICS (S, F, FT) *-HOUSING COLOR (B, W)

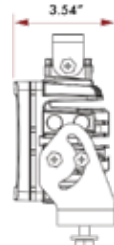
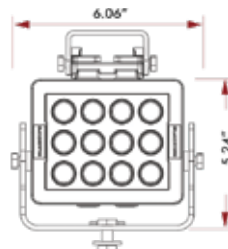

12 LED WORK AND AREA LIGHT

LEDS	12 x 7W
RAW LUMENS	9,600
EFFECTIVE LUMENS	6,697
OPT. HOUSING COLORS	BLACK OR WHITE
OPT. BEAM PATTERNS	SPOT, FLOOD, COMBO
DIMENSIONS	6.06" x 5.24" x 3.54"
BUILT-IN SWITCH	YES
WATTAGE	84W
AMP DRAW (@12V)	7.0A
INPUT VOLTAGE DC	11-65V DC
CONNECTOR	DEUTSCH DT04-2P
EMC APPROVAL	CISPR25 CLASS 3
VIBRATION RATING	21.2 GRMS

5 LED WORK AND AREA LIGHT | FT-WL-X-5-**-*

KEY FEATURES

- Outstanding Light Output
- Five Mounting Configurations
- CE Approved
- Anti-Corrosion Coating



FT-WL-X-5--***
**-OPTICS (S, F, FT) *-HOUSING COLOR (B, W)

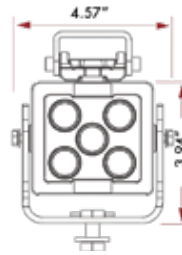

5 LED WORK AND AREA LIGHT

LEDS	5 x 7W
RAW LUMENS	4,000
EFFECTIVE LUMENS	3,305
OPT. HOUSING COLORS	BLACK OR WHITE
OPT. BEAM PATTERNS	SPOT, FLOOD, COMBO
DIMENSIONS	3.94" x 4.57" x 2.95"
BUILT-IN SWITCH	YES
WATTAGE	35W
AMP DRAW (@12V)	2.9A
INPUT VOLTAGE DC	11-65V DC
CONNECTOR	DEUTSCH DT04-2P
EMC APPROVAL	CISPR25 CLASS 3
VIBRATION RATING	21.2 GRMS

4 LED WORK AND AREA LIGHT | FT-WL-X-4-*

KEY FEATURES

- 60° Wide Flood Optics
- Flexible Mounting Configurations
- CE Approved
- Anti-Corrosion Coating



FT-WL-X-4-*
*-HOUSING COLOR (B, W)

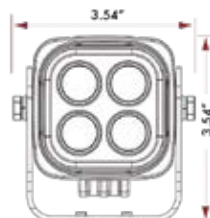

4 LED WORK AND AREA LIGHT

LEDS	4 x 3W
RAW LUMENS	2,000
EFFECTIVE LUMENS	950
OPT. HOUSING COLORS	BLACK OR WHITE
BEAM PATTERN	FLOOD
DIMENSIONS	3.54" x 3.54" x 2.32"
BUILT-IN SWITCH	NO
WATTAGE	12W
AMP DRAW (@12V)	1.0A
INPUT VOLTAGE DC	9-32V DC
CONNECTOR	DEUTSCH DT04-2P
EMC APPROVAL	CISPR25 CLASS 3
VIBRATION RATING	21.2 GRMS

4 LED GENERAL PURPOSE UTILITY LIGHT | FT-WL-2000-**-*

KEY FEATURES

- Ultra-Reliable Entry Level Utility/ Work Light
- NFPA 1901 Compliant Flood Light

AVAILABLE WITH **COLORLED** LEDS



FT-WL-X-5--***

** -OPTICS (S, F, FT) * -HOUSING COLOR (B, W)

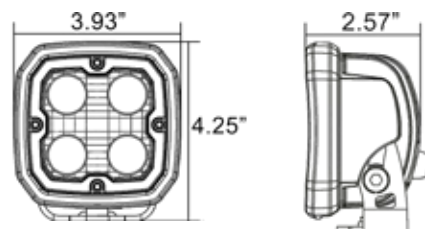

4 LED GENERAL PURPOSE UTILITY LIGHT

LEDS	4 x 5W
RAW LUMENS	2,115
EFFECTIVE LUMENS	1,164
OPT. HOUSING COLORS	BLACK OR WHITE
OPT. ALT. LED COLORS	BLUE, RED, GREEN, AMBER
OPT. BEAM PATTERNS	SPOT, FLOOD, COMBO
DIMENSIONS	3.93" x 4.25" x 2.57"
BUILT-IN SWITCH	NO
WATTAGE	20W
AMP DRAW (@12V)	1.66A
INPUT VOLTAGE DC	9-32V DC
CONNECTOR	DEUTSCH DT04-2P
EMC APPROVAL	CISPR25 CLASS 3

7 LED WORK AND AREA LIGHT | FT-WL-3500-**-*

KEY FEATURES

- Ultra-Reliable Work Light
- NFPA 1901 2016 compliant
- Variety of Optics Available



FT-WL-3500--***

** -OPTICS (S, F, FT) * -HOUSING COLOR (B, W)

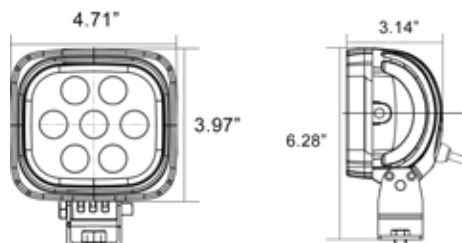

7 LED WORK AND AREA LIGHT

LEDS	7 x 5W
RAW LUMENS	3,696
EFFECTIVE LUMENS	2,587
OPT. HOUSING COLORS	BLACK OR WHITE
OPT. BEAM PATTERNS	SPOT, FLOOD, COMBO
DIMENSIONS	4.71" x 3.97" x 3.14"
BUILT-IN SWITCH	YES
WATTAGE	35W
AMP DRAW (@12V)	2.9A
INPUT VOLTAGE DC	11-65V DC
CONNECTOR	DEUTSCH DT04-2P
EMC APPROVAL	CISPR25 CLASS 3
VIBRATION RATING	15.6 GRMS

SPECIALTY LIGHTS



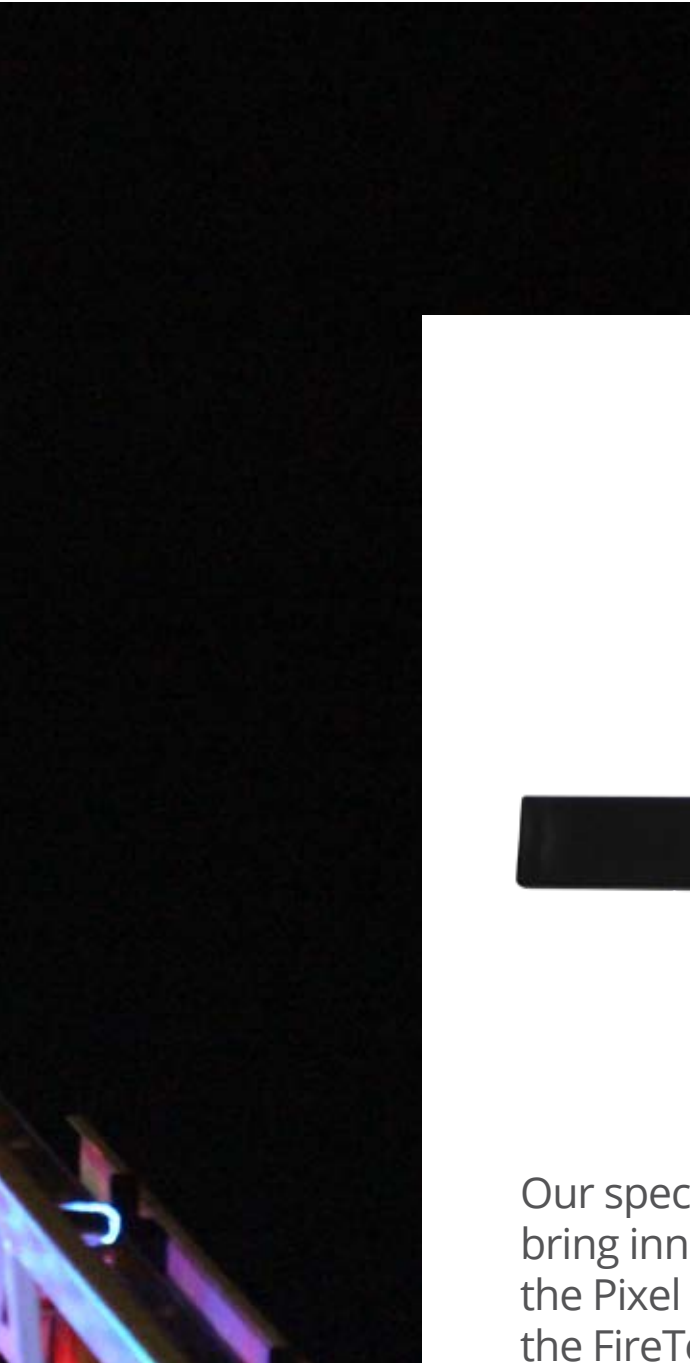

Our specialty lights break the mold of tradition and bring innovation to new heights. From products like the Pixel Ladder Light and the Laser Light Cannons, the FireTech® brand has you covered.



PIXEL LADDER LIGHT

THE MOST VERSATILE AERIAL LIGHT EVER CREATED



FT-PXL-61

KEY FEATURES

- Indicate Key Aerial Statuses
- Support up to 5 Ladder Sections
- Choose Any Color/Mode

LIMITLESS FUNCTIONALITY

Adding the Pixel Ladder Light to your fire apparatus aerial device brings a whole new level of sophistication. Each LED in the system is individually controlled by our System Manager, and gives you the ability to choose from a variety of functions on-the-fly. These functions can be solid colors to illuminate the ladder rungs or can be tied to a variety of functions* to indicate certain aerial device statuses. These can include things like flashing when the aerial is in motion, changing colors to indicate when certain load limits are reached, or visually indicating emergency-evacuation or water flowing.

In addition to functionality associated with firefighting, we know aerial devices are often used in parades or community support functions. Supporting the local high school on game night? Fly the school colors! Celebrating Breast Cancer Awareness Month? At the tap of a button, turn the aerial Pink! You can even choose things like "Rocket" or "Twinkle" or "American Flag" all without ever losing the primary function of being the best darn aerial rung light ever produced for a fire.



CHOOSE ANY COLOR

The system manager allows for user-programmable selection of any "solid" color or combination of colors (white, red, blue, green, orange, pink, rainbow, red/white/blue, etc.).



CHOOSE YOUR FLASH PATTERN

Program any input wire to act as a flashing indicator. This can be wig/wag, scrolling, or blinking and can be used to indicate a variety of aerial conditions.



CHOOSE THE INTENSITY

The entire system is dimmable and can be configured to come on at a variety of intensities.

AVAILABLE FUNCTIONS

FULL

Entire light strip on. Color can be any RGB value or white.

WIGWAG

Even/odd groups of the light strip flash on and off at a selected rate.

WIPE

LEDs incrementally turn on going up/down the light strip at a selected rate, creating the effect of lights “wiping” up/down the ladder.

FLASH

Entire light strip flashes on and off at a selected rate.

RAINBOW

Entire light strip turns on and flows rainbow colors up/down the ladder.

TWINKLE

Random LEDs along the light strip twinkle on and off at a selected rate, ramping up in brightness to the “full” state and then back down during the twinkle duration.

PIXEL LADDER LIGHT STRIPS

VOLTAGE RANGE	9-32V DC
AMP DRAW (@12V)	.78A
OPERATING TEMP.	-40C TO 60C
INGRESS PROTECTION RATING	IP67 AND IP6K9K
DIMENSIONS	60.94" x 0.85" x 0.39"



PIXEL CONTROLLER | FT-PXL-SM-001

The Pixel Controller (sold separately), otherwise known as the “System Manager,” has 10 user-programmable input wires. These wires can be assigned to any of the above functions or colors. Apparatus manufacturers can then assign switches or outputs from their electrical system to energize any of the 10 pre-selected functions.

Installation of this product requires engineering support from both the apparatus manufacturer and the FireTech team. Training will be provided to any interested apparatus OEM at no cost. This product may or may not be compatible with certain applications or aerial devices. Custom programming, functionality, and integration support are available to apparatus OEMs.

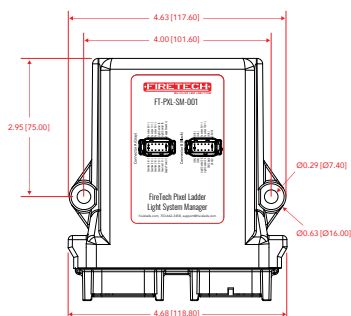

PIXEL CONTROLLER

VOLTAGE RANGE	9-32V DC
OPERATING TEMP.	-40C TO 60C
INGRESS PROTECTION RATING	IP67 AND IP6K9K
RS4-85 BAUD	19,200
DIMENSIONS	4.680" x 5.240" x 1.420"
HARNES CONNECTORS	DEUTSCH DTM06-12SA + DTM06-12SB

LASER CANNON

PRECISION LASER LIGHTING TECHNOLOGY



KEY FEATURES

- High Intensity Spherical-Type Optic
- Visible Daytime Beam
- Compact Design

PART NUMBER: **FT-LZC2-4-B**

VISIBLE IN BROAD DAYLIGHT

The major problem the laser cannon addresses is daytime visibility. The spherical-type optic focuses the laser emitter with so much intensity that even during the brightest day the light beam is still visible to the operator.



DIMENSIONS

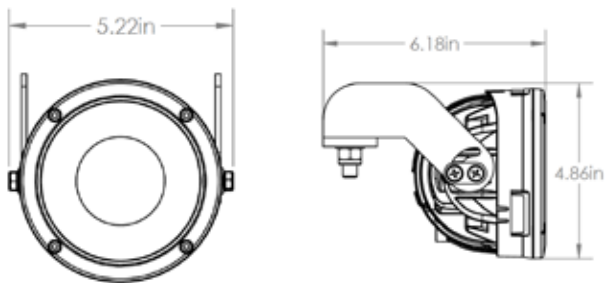

LASER CANNON

LASER	WP-PX BLUE LAKE
EFFECTIVE LUMENS	670
OPT. HOUSING COLORS	BLACK
DIMENSIONS	5.22" x 4.86" x 6.18"
WATTAGE	14W
AMP DRAW (@12V)	1.17A
INPUT VOLTAGE DC	9-32V DC



RETROFIT LIGHTING

REUSE YOUR EXISTING HOUSING



FT-P48-NFKIT

NIGHTFIGHTER KIT

KEY FEATURES

- Direct Drop-In Nightfighter / PAR 46 Replacement
- 2x Flood, 1x Spot Fixture
- Reduced Power Consumption (40W Each)

NIGHTFIGHTER KIT

LEDS	12 x 10W P7 CREE XML LEDS
RAW LUMENS	10,800
EFFECTIVE LUMENS	7,560
HOUSING COLOR	SILVER
OPT. BEAM PATTERNS	SPOT OR FLOOD
REPLACES	ANY PAR46 FIXTURE
WATTAGE	120W

PAR 46 UPGRADE | FT-P48-*



FT-P48-*
*-OPTICS (S, F)

PAR 46 UPGRADE

LEDS	4 x 10W P7 CREE XML LEDS
RAW LUMENS	3,600
EFFECTIVE LUMENS	2,520
HOUSING COLOR	SILVER
OPT. BEAM PATTERNS	SPOT OR FLOOD
REPLACES	ANY PAR46 FIXTURE
WATTAGE	40W

ITEM #	DESCRIPTION
FT-P48-F	1x Flood Fixture
FT-P48-S	1x Spot Fixture



FIRETECH® GRILLES

GRILLE REPLACEMENTS



KEY FEATURES

- OEM Location Mounting Uses Factory Installed Mounts
- Meets and Exceeds Necessary Airflow Standards
- Two Single-LED Long Distance Light Cannons
- Two Multi-LED Wide Spot Light Cannons

PURPOSE BUILT FOR YOUR APPARATUS

The FireTech LED Grilles are designed with (4) 7X4 warning lights and (4) off-road light cannons. Two cannons sport a single, highly-focused LED for long distance projection, while the other two multi-optic cannons project light in a wide spot beam to fill in the foreground. These fixtures are a bolt-on solution, giving maximum visibility to the front of your fire or emergency vehicle.



WATCH THE **INSTALLATION VIDEO** AND
LEARN MORE ABOUT FIRETECH GRILLES



FIRETECH GRILLE REPLACEMENT OPTIONS



'11-'16 FORD SUPER DUTY



'17-'19 FORD SUPER DUTY



'20+ FORD SUPER DUTY



'13-'18 DODGE RAM HD



'19+ DODGE RAM HD



'03+ FREIGHTLINER M2



'19+ INTERNATIONAL M7

CONFIGURE PART NUMBER

1.) PICK YOUR MODEL

"03FM2"

'03+ FREIGHTLINER M2

"09F150"

'09-'12 FORD F150

"11FSD"

'11-'16 FORD SUPER DUTY

"17FSD"

'17-'19 FORD SUPER DUTY

"17FSDC"

'17-'19 FORD SUPER DUTY W/CAMERA

"20FSD"

'20+ FORD SUPER DUTY

"20FSDC"

'20+ FORD SUPER DUTY W/CAMERA

"13DHD"

'13-'18 DODGE RAM

(PICK YOUR MODEL CONTINUED)

"19DHD"

'19+ DODGE RAM

"19IM7"

'19+ INTERNATIONAL M7

2.) PICK YOUR WARNING LIGHTS (OPTIONAL)



EACH LIGHT (1-4) IS CONFIGURABLE WITH:

"FR7C-R" - CLEAR LENS, RED LED

"FR7C-B" - CLEAR LENS, BLUE LED

3.) PICK YOUR WARNING LIGHT BEZEL COLOR

"FR7MC"

CHROME TRIM BEZEL

"FR7MB"

BLACK TRIM BEZEL

PICK YOUR MODEL, THEN USE THE CONFIGURATION SHEET TO PICK YOUR (4) WARNING LIGHTS & BEZEL COLOR

MODEL WARNING LIGHTS BEZEL
 ↓ ↓ ↓
 FT-CG2GKIT- _____ - _____ - _____

CAMERA-INTEGRATED LIGHTS

SPECIFIC APPLICATION LIGHTING AND EQUIPMENT



KEY FEATURES

- Easy Install with Existing Display
- Optional Flashing Endcaps
Packaged with 24 LED MiniBrow
- 7" Standalone Display Option (sold separately)
- Optimal Backup Camera

MINIBROW® CAMERA SCENE LIGHT

Visibility is the key to safety on a fire scene. Whether it's lighting a dark area at night or providing a live video feed from one side of the apparatus to the other during the day, the FireTech brand has you covered. Some of our OEM customers brought us a need for a single fixture with multiple functions, one of them being a need for visibility during the day.

This camera can be wired into a display (like the Class 1 "UltraView") on a multiplex fire apparatus, or for smaller rigs, can be wired to the factory harness for seamless integration with the truck's factory-installed backup camera system. For rigs without integrated screens or backup systems, a simple aftermarket video monitor can be installed for minimal cost.

MINIBROW CAMERA LIGHT

LEDS	18 x 5W LEDS - 6 x 3W LEDS
RAW LUMENS	9,504 - 19,008
EFFECTIVE LUMENS	6,652 - 13,305
OPT. HOUSING COLORS	BLACK OR WHITE
OPT. BEAM PATTERNS	SPOT, FLOOD, COMBO
LENGTHS	26.39" - 49.09"
INPUT VOLTAGE DC	9-32V DC
CONNECTOR	2X DEUTSCH DT04-2P 1X RCA, 1X 12V CANON

ITEM

FT-MB-18-C-F-*
FT-MB-24-C-F-*
FT-MB-30-C-F-*
FT-MB-36-C-F-*

DESCRIPTION

2x FT-MB-9-F-* + Camera Bridge
2x FT-MB-12-F-* + Camera Bridge
2x FT-MB-15-F-* + Camera Bridge
2x FT-MB-18-F-* + Camera Bridge

LENGTH

26.39" Overall
33.95" Overall
41.51" Overall
49.09" Overall

**SCAN TO LEARN MORE ABOUT THE
MINIBROW CAMERA SCENE LIGHT**

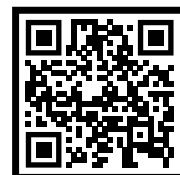

LED LIGHT WITH INTEGRATED COLOR CAMERA | FT-WL-3500-**-F-*

KEY FEATURES

- Full Color Camera
- Glare Shield Included
- Easy Install with Existing Display
- Powerful LEDs for Night Use



FT-WL-3500--F-***
**** - FORWARD OR REAR FACING CAMERA (C, RC)**
*** - HOUSING COLOR (B, W)**

LED LIGHT WITH INTEGRATED COLOR CAMERA

LEDS	6 x 5W CREE
RAW LUMENS	3,168
EFFECTIVE LUMENS	2,217
OPT. HOUSING COLORS	BLACK OR WHITE
BEAM PATTERN	FLOOD
DIMENSIONS	4.72" x 5.50" x 4.88"
WATTAGE	30W
AMP DRAW (@12V)	2.6A
INPUT VOLTAGE DC	9-32V DC
CONNECTOR	DEUTSCH DT04-6P
EMC APPROVAL	CISPR25 CLASS 1 / CE
VIBRATION RATING	15.6 GRMS

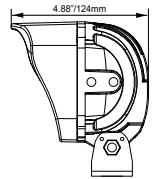
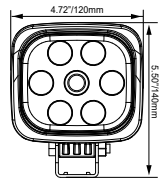

ITEM

DESCRIPTION

FT-WL-3500-C-F-B	Forward Facing Camera, Normal Image, Black Housing
FT-WL-3500-C-F-W	Forward Facing Camera, Normal Image, White Housing
FT-WL-3500-RC-F-B	Forward Facing Camera, Mirror Image, Black Housing
FT-WL-3500-RC-F-W	Forward Facing Camera, Mirror Image, White Housing

7" MULTI-FUNCTIONAL MONITOR | HV-QMA7003

KEY FEATURES

- Image Adjustable for Horizontal, Vertical, Mirror, and Normal Viewing
- 4 Camera Inputs, 1 Video Output, 1 Audio Output
- Auto Switches to Back-Up, Left, or Right Side Camera Views
- IP67 Waterproof



HV-QMA7003

WHAT'S INCLUDED

The 7" Monitor ships with two mounting brackets, a sun shade, four video input harnesses, a master wiring harness, and a wireless remote controller. Attaching this monitor to any FireTech Camera-Integrated Scene Light is a breeze.



MOUNTING BRACKETS





Don't let concern over mounting stop you from getting the most out of your rig after dark! The FireTech® Mounting Bracket kits allow for versatile installation in a variety of applications.



MOUNTING BRACKETS

MOUNTING AND INSTALLATION

FORD SUPER DUTY WINDSHIELD BROW LIGHT MOUNTING KIT

The FireTech® Brow Light can easily be mounted to the leading edge of most Ford® SuperDuty F250-F550 cabs. This bracket kit allows installation of an ultra-low-profile brow light in your station with basic tools and a couple hours of time. This particular configuration mates seamlessly to the FT-B-46-ML3 (with center 3 ID lights) or the FT-B-50 (no marker lights).

MODELS

ITEM #	DESCRIPTION
P-OEBRACKET-09FSD-B	'09-'16 BRACKETS (BLACK)
P-OEBRACKET-09FSD-W	'09-'16 BRACKETS (WHITE)
P-OEBRACKET-17FSD-B	'17+ BRACKETS (BLACK)
P-OEBRACKET-17FSD-W	'17+ BRACKETS (WHITE)
FT-B-50-B-09FSDKIT	BRACKETS WITH 50" BROW LIGHT (NO MARKER LIGHTS) (BLACK)
FT-B-50-W-09FSDKIT	BRACKETS WITH 50" BROW LIGHT (NO MARKER LIGHTS) (WHITE)
FT-B-46-ML3-B-09FSDKIT	BRACKETS WITH 50" BROW LIGHT (3 MARKER LIGHTS) (BLACK)
FT-B-46-ML3-W-09FSDKIT	BRACKETS WITH 50" BROW LIGHT (3 MARKER LIGHTS) (WHITE)
FT-B-50-B-17FSDKIT	BRACKETS WITH 50" BROW LIGHT (NO MARKER LIGHTS) (BLACK)
FT-B-50-W-17FSDKIT	BRACKETS WITH 50" BROW LIGHT (NO MARKER LIGHTS) (WHITE)
FT-B-46-ML3-B-17FSDKIT	BRACKETS WITH 50" BROW LIGHT (3 MARKER LIGHTS) (BLACK)
FT-B-46-ML3-W-17FSDKIT	BRACKETS WITH 50" BROW LIGHT (3 MARKER LIGHTS) (WHITE)

'09-'16 SD A-PILLAR MOUNT



'17+ SD A-PILLAR MOUNT



LICENSE PLATE MOUNT



EASILY MOUNT AN FT-MB-9 (9 LED MINIBROW) TO THE LICENSE PLATE OF NEARLY ANY VEHICLE!

FT-MB-9-LP--*** (LIGHT + BRACKET)
FT-LPBRKT (BRACKET ONLY)



HIVIZ LIGHTING, INC.



149 Twin Springs Road
Hendersonville, NC 28792



P: (703) 662-3458



firetech@hivizleds.com
www.hivizleds.com