

# METRO FIRE

## APPARATUS SPECIALISTS, INC.

Apparatus #524077-01 is in its option period until January 1, 2025. This apparatus is currently a Model #3106 and can be modified to a #3114, #3116, or #3120.

### S-180 Model #3106

Pump Location: Side Mount

Tank Size: 1000/20

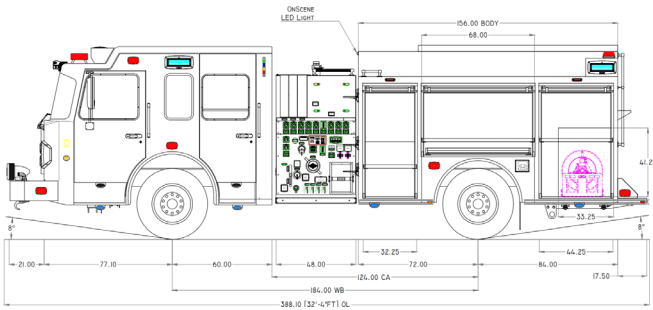

### S-180 Model #3114

Pump Location: Side Mount

Tank Size: 750/20

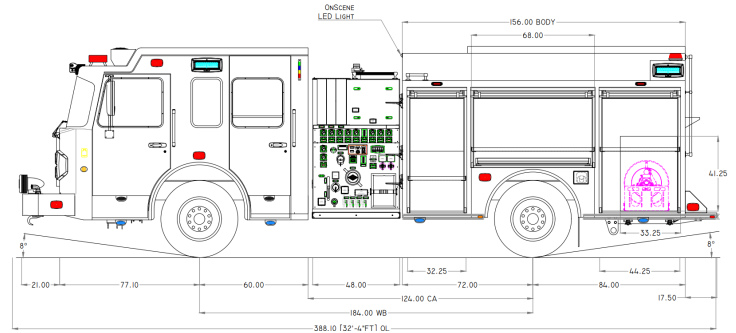

### S-180 Model #3116

Pump Location: Top Mount

Tank Size: 1000/20

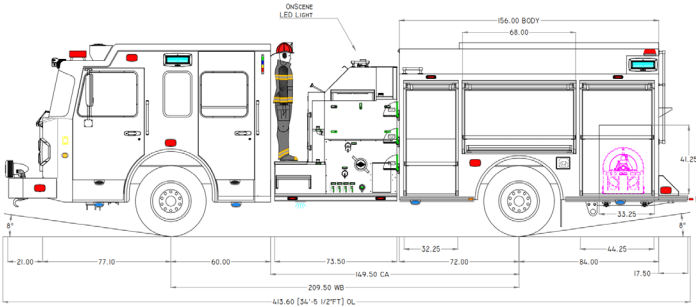

### S-180 Model #3120

Pump Location: Top Mount

Tank Size: 750/20

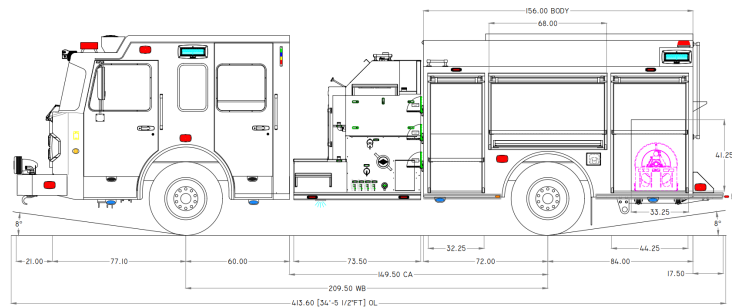

Please contact us [here](#) with any questions.